



---

# State-space average Modeling of DC-DC Converters with parasitic in Discontinuous Conduction Mode (DCM).

A THESIS SUBMITTED IN  
PARTIAL FULFILLMENT OF THE REQUIREMENTS FOR  
THE DEGREE OF

BACHELOR OF TECHNOLOGY  
IN  
ELECTRICAL ENGINEERING.

By

Antip Ghosh

Mayank Kandpal

Under the guidance of

**Prof. S. Samanta**



Department of Electrical Engineering  
National Institute of Technology, Rourkela



**NATIONAL INSTITUTE OF TECHNOLOGY  
ROURKELA**

## **CERTIFICATE**

This is to certify that the thesis entitled” **State-space average Modeling of DC-DC Converters with parasitic in Discontinuous Conduction Mode**” submitted by Mr Antip Ghosh and Mr Mayank Kandpal in partial fulfilment of the requirements for the award of Bachelor of Technology Degree in Electrical Engineering at National Institute of Technology, Rourkela (Deemed University) is an authentic work carried out by him under my supervision and guidance.

To the best of my knowledge, the matter embodied in the thesis has not been submitted to any other University/ Institute for the award of any degree or diploma.

**Prof. S. Samanta**

Department of Electrical Engineering  
National Institute of Technology  
Rourkela – 769008

DATE -..../05/10



## ACKNOWLEDGEMENT

No thesis is created entirely by an individual, many people have helped to create this thesis and each of their contribution has been valuable. My deepest gratitude goes to my thesis supervisor, Prof. S. Samanta, Department of Electrical Engineering, for his guidance, support, motivation and encouragement throughout the period this work was carried out. His readiness for consultation at all times, his educative comments, his concern and assistance even with practical things have been invaluable. I would also like to thank all professors and lecturers, and members of the department of Electrical Engineering for their generous help in various ways for the completion of this thesis.

Antip Ghosh

Roll. No. 10602021

Dept. of Electrical Engineering

NIT Rourkela

Mayank Kandpal

Roll. No. 10602056

Dept. of Electrical Engineering

NIT Rourkela



---

## Contents

List of Figures	05
Abstract	06
<b>1 Introduction</b>	<b>07</b>
1.1 Overview	08
1.2 Different topologies.	08
1.3 Different mode of operation.	10
1.4 About the thesis.	14
<b>2 State Space Averaging</b>	<b>15</b>
2.1 Procedure For State-Space Averaging.	16
<b>3 Analysis In DCM</b>	<b>17</b>
3.1 Overview.	18
3.2 Framework.	19
3.3 Reduced Order Model.	23
3.4 Full Order Model.	29
<b>4 Inclusion Of Parasitics In Model</b>	<b>46</b>
4.1 Overview	47
4.2 Transfer functions derivation considering parasitics	48
<b>5 Results and Conclusion</b>	<b>57</b>
<b>References</b>	<b>60</b>

## List of Figures

S.I.No.	Name of Figure
1.1	Buck Converter Circuit Diagram
1.2	Boost Converter Circuit Diagram
1.3	Buck-Boost Converter Circuit Diagram
1.4	On-State Configuration for Boost Converter
1.5	Off-State Configuration for Boost Converter
1.6	On-State Configuration for Buck Converter
1.7	Off-State Configuration for Buck Converter
3.1	Waveform denoting Inductor Current in DC-DC Converter
3.2	Including $I_{load}$ in Boost Converter(ON Position)
3.3	Including $I_{load}$ in Boost Converter(OFF Position)
4.1	Boost Converter Circuit with parasitics of switched-inductor cell

# ABSTRACT

Discontinuous Conduction Mode occurs due to low load current operation of converters which employ current or voltage unidirectional switches. The switching ripples in inductor current or capacitor voltage causes the polarity to reverse of the applied switch current or voltage and thus a zero current mode is reached. Nowadays, converters are so designed, to operate in DCM for all loads due to its higher efficiency and lower losses. In this thesis, we have derived the Reduced Order & Full Order Averaged Models for the Buck and Boost configuration of converters. Also we calculated the output transfer function of boost converter which can be further utilized for designing of controller. Then, parasites effects have been taken into account for Boost Converter and accordingly, its various transfer functions (Control, Output Impedance, etc.) and various bode diagram have been plotted and compared with ideal cases.

# Chapter 1

## INTRODUCTION

1.1 Overview.

1.2 Different topologies.

1.3 Different mode of operation.

1.4 About the thesis.

## 1.1 Overview

Over the years as the portable electronics industry progressed, different requirements evolved such as increased battery lifetime, small and cheap systems, brighter, full-color displays and a demand for increased talk-time in cellular phones. An ever increasing demand from power systems has placed power consumption at a premium. To keep up with these demands engineers have worked towards developing efficient conversion techniques and also have resulted in the subsequent formal growth of an interdisciplinary field of Power Electronics. However it comes as no surprise that this new field has offered challenges owing to the unique combination of three major disciplines of electrical engineering: electronics, power and control.

### DC-DC converters

These are electronic devices that are used whenever we want to change DC electrical power efficiently from one voltage level to another. Generically speaking the use of a switch or switches for the purpose of power conversion can be regarded as an SMPS. A few applications of interest of DC-DC converters are where 5V DC on a personal computer motherboard must be stepped down to 3V, 2V or less for one of the latest CPU chips; where 1.5V from a single cell must be stepped up to 5V or more, to operate electronic circuitry. Our main focus is that in above mentioned applications is that to alter dc energy from a particular level to other with minimum loss. The need for such converters have risen due to the fact that transformers are unable to function on dc. A converter is not manufacturing power. Whatever comes at the output has to come only from input. Efficiency cannot be made equal to 100%, so input power is always somewhat larger than output power.

## 1.2 Different topologies

- Buck converter
- Boost converter
- Buck –boost converter

### Buck converter:-



A Buck converter is a step down DC-DC converter consisting mainly of inductor and two switches (usually a transistor switch and a diode) for controlling inductor. It fluctuates between connection of inductor to source voltage to accumulate energy in inductor and then discharging the inductor's energy to the load.

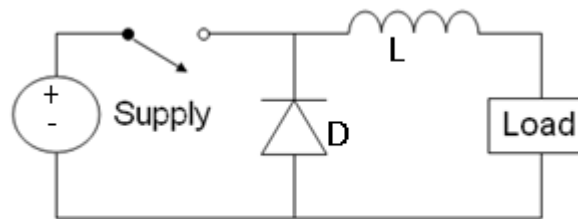

Fig1.1

When the switch pictured above is closed (i.e. On-state), the voltage across the inductor is  $V_L = V_i - V_o$ . The current flowing through inductor linearly rises. The diode doesn't allow current to flow through it, since it is reverse-biased by voltage  $V$ .

For Off Case (i.e. when switch pictured above is opened), diode is forward biased and voltage is  $V_L = -V_o$  (neglecting drop across diode) across inductor. The inductor current which was rising in ON case, now decreases.

### **Boost converter:-**

A boost converter (step-up converter), as its name suggests steps up the input DC voltage value and provides at output. This converter contains basically a diode, a transistor as switches and at least one energy storage element. Capacitors are generally added to output so as to perform the function of removing output voltage ripple and sometimes inductors are also combined with.

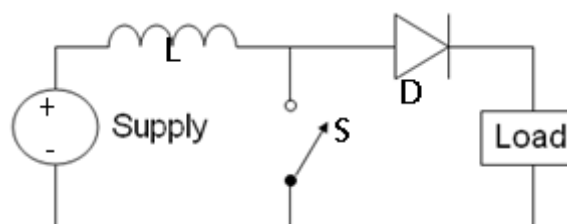

Fig 1.2

Its operation is mainly of two distinct states:

- During the ON period, Switch is made to close its contacts which results in increase of inductor current.
- During the OFF period, Switch is made to open and thus the only path for inductor current to flow is through the fly-back diode 'D' and the parallel combination of capacitor and load. This enables capacitor to transfer energy gained by it during ON period.

### **Buck–boost converter:-**

This type of converter gives output voltage which is having greater or lesser magnitude than input value of voltage. Based on duty ratio of switching transistor, output voltage is adjusted.

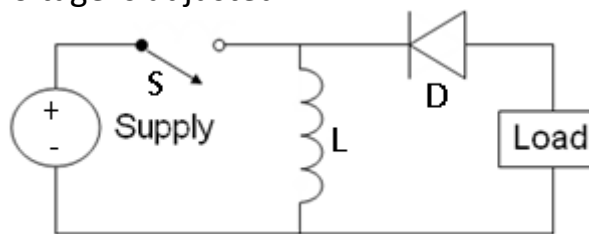

Fig 1.3

When switch is turned ON, then the inductor is connected to input voltage source. This leads to accumulation of energy in the inductor and capacitor performs the action of supplying energy to load.

When switch is turned OFF, the inductor is made to come in contact with capacitor and load, so as to provide energy to load and discharged capacitor.

## **1.3 Different modes of operation:-**

- a) A dc-dc converter is said to be operating in CCM, if inductor current never reaches to zero.
- b) A dc-dc converter is said to be operating in DCM, if inductor current reaches zero and remains there for certain period of time.

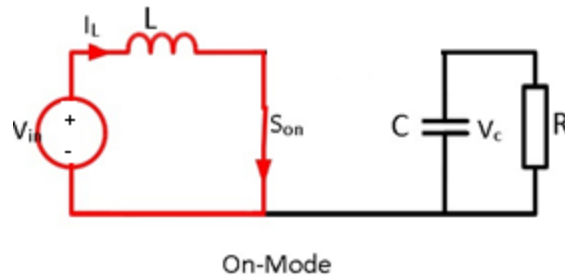

Fig 1.4

In a Boost Converter, During 'On' Mode:-

$$\text{From KVL} \quad v_{in} - L \frac{di_L}{dt} = 0$$

$$\text{From KCL} \quad \frac{v_c}{R} + C \frac{dv_c}{dt} = 0$$

$$\text{In State Space form:-} \begin{bmatrix} \frac{di_L}{dt} \\ \frac{dv_c}{dt} \end{bmatrix} = \begin{bmatrix} 0 & 0 \\ 0 & -\frac{1}{RC} \end{bmatrix} \begin{bmatrix} i_L \\ v_c \end{bmatrix} + \begin{bmatrix} \frac{1}{L} \\ 0 \end{bmatrix} v_{in}; v_o = [0 \quad 1] \begin{bmatrix} i_L \\ v_c \end{bmatrix}$$

During 'OFF' Mode:-

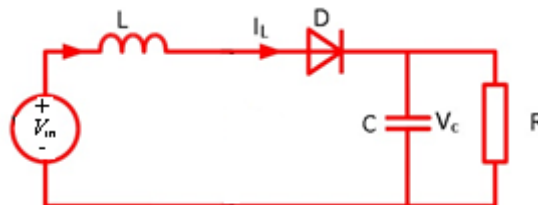

Fig 1.5

$$\text{From KVL} \quad v_{in} - v_c - L \frac{di_L}{dt} = 0$$

$$\text{From KCL} \quad i_L - \frac{v_c}{R} - \frac{C dv_c}{dt} = 0$$

$$\text{In State Space form:-} \begin{bmatrix} \frac{di_L}{dt} \\ \frac{dv_c}{dt} \end{bmatrix} = \begin{bmatrix} 0 & -\frac{1}{L} \\ \frac{1}{C} & -\frac{1}{RC} \end{bmatrix} \begin{bmatrix} i_L \\ v_c \end{bmatrix} + \begin{bmatrix} \frac{1}{L} \\ 0 \end{bmatrix} v_{in}; v_o = [0 \quad 1] \begin{bmatrix} i_L \\ v_c \end{bmatrix}$$

During Discontinuous Conduction Mode:-

From KVL  $\frac{di_L}{dt} = 0$

From KCL  $\frac{v_C}{R} + C \frac{dv_C}{dt} = 0$

In State Space form:- 
$$\begin{bmatrix} \frac{di_L}{dt} \\ \frac{dv_C}{dt} \end{bmatrix} = \begin{bmatrix} 0 & 0 \\ 0 & -\frac{1}{RC} \end{bmatrix} \begin{bmatrix} i_L \\ v_C \end{bmatrix} + \begin{bmatrix} 0 \\ 0 \end{bmatrix} v_{in}; v_o = \begin{bmatrix} 0 & 0 \end{bmatrix} \begin{bmatrix} i_L \\ v_C \end{bmatrix}$$

In a Buck Converter, During 'ON' Mode:-

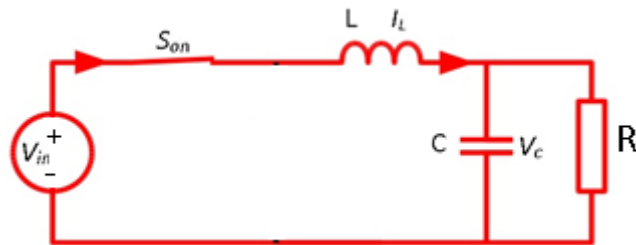

Fig 1.6

From KVL  $v_{in} - L \frac{di_L}{dt} - v_C = 0$

From KCL  $\frac{v_C}{R} + C \frac{dv_C}{dt} - i_L = 0$

In State Space form:- 
$$\begin{bmatrix} \frac{di_L}{dt} \\ \frac{dv_C}{dt} \end{bmatrix} = \begin{bmatrix} 0 & -\frac{1}{L} \\ \frac{1}{C} & -\frac{1}{RC} \end{bmatrix} \begin{bmatrix} i_L \\ v_C \end{bmatrix} + \begin{bmatrix} \frac{1}{L} \\ 0 \end{bmatrix} v_{in}; v_o = \begin{bmatrix} 0 & 1 \end{bmatrix} \begin{bmatrix} i_L \\ v_C \end{bmatrix}$$

During 'OFF' Mode:-

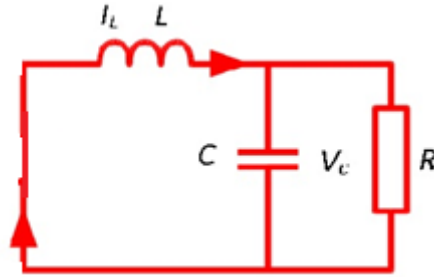

Fig 1.7

$$\text{From KVL} \quad v_C + L \frac{di_L}{dt} = 0$$

$$\text{From KCL} \quad i_L - \frac{v_C}{R} - C \frac{dv_C}{dt} = 0$$

$$\text{In State Space form:-} \begin{bmatrix} \frac{di_L}{dt} \\ \frac{dv_C}{dt} \end{bmatrix} = \begin{bmatrix} 0 & -\frac{1}{L} \\ \frac{1}{C} & -\frac{1}{RC} \end{bmatrix} \begin{bmatrix} i_L \\ v_C \end{bmatrix} + \begin{bmatrix} 0 \\ 0 \end{bmatrix} v_{in}; v_o = \begin{bmatrix} 0 & 1 \end{bmatrix} \begin{bmatrix} i_L \\ v_C \end{bmatrix}$$

*During Discontinuous Conduction Mode:-*

$$\text{From KVL} \quad \frac{di_L}{dt} = 0$$

$$\text{From KCL} \quad \frac{v_C}{R} + C \frac{dv_C}{dt} = 0$$

$$\text{In State Space form:-} \begin{bmatrix} \frac{di_L}{dt} \\ \frac{dv_C}{dt} \end{bmatrix} = \begin{bmatrix} 0 & 0 \\ 0 & -\frac{1}{RC} \end{bmatrix} \begin{bmatrix} i_L \\ v_C \end{bmatrix} + \begin{bmatrix} 0 \\ 0 \end{bmatrix} v_{in}; v_o = \begin{bmatrix} 0 & 0 \end{bmatrix} \begin{bmatrix} i_L \\ v_C \end{bmatrix}$$

---

## 1.4 About the thesis

For modelling of converter two technique can be use

- Circuit averaging technique.
- State space averaging technique.

The latter approach has a number of advantages over circuit averaging technique, these include:

- More compact representation of equations.
- Ability to obtain more transfer functions than was possible using circuit averaging technique.
- Both DC and AC transfer functions are obtained with more ease

So in this thesis we are using State space averaging technique to derive Reduced Order and Full Order Averaged Models for both the buck and boost converters [1] and the output transfer function by taking a  $I_{load}$  as constant current source. Then, parasites effects have been taken into account for Boost Converter as parasitic are always present in system and accordingly, its various transfer functions (Control, Output Impedance, etc.) and various bode diagram have been plotted and compared with ideal cases.



# CHAPTER 2

## STATE SPACE AVERAGING

### 2.1 Procedure For State-Space Averaging.

## 2.1 Procedure For State-Space Averaging

- Draw the linear switched circuit model for each state of the switching converter.
- Write state equations for each switched circuit model using Kirchhoff's voltage and current laws
- Averaging the State- space Equation using the duty ratio.
- Perturb the averaged state equation to yield steady-state (DC) and dynamic (AC) terms and eliminate the product of any AC terms
- Transform the AC equations into S- domain to solve for Transfer Function.



# CHAPTER 3

## ANALYSIS IN DCM MODE

3.1 Overview.

3.2 Framework.

3.3 Reduced Order Model.

3.4 Full Order Model.

## 3.1 Overview

When the implementation of ideal switches of a DC-DC converter are done by using current unidirectional and /or voltage unidirectional semiconductor switches, one or more new modes of operation known as DISCONTINUOUS CONDUCTION MODE (DCM) can occur. It occurs when the load current requirement is very low for certain operations like in the case of SMPS used in computers, converters require a very low current during Hibernation or Sleep Mode and switching ripples in inductor current or capacitor voltage causes the polarity to reverse of the applied switch current or voltage and thus an zero current mode is reached giving its name DCM. It is frequently observed in inverters, DC-DC rectifiers and converters containing two quadrant switches, etc. as it is usually required that it operates with their loads removed. Nowadays, some converters are purposely designed to operate in DCM for all loads [2].

Various efforts had been done in the modelling of DCM PWM converters [3]–[6]. These models can be classified either analytically [3], [5] or equivalent circuit form [4], [6], and can be grouped into two main divisions like:-

- reduced-order model [3], [6];
- full-order model [5], [6].

The inductor current does not appear as a state variable in reduced order model, which is undesirable for those applications where the paramount control target is inductor current. In low frequency range, its prediction is accurately defining the converter's behaviour. But problem lies at large frequencies, particularly in phase response, where large discrepancies do occur. Unlike in reduced order, in full order model inductor current is retained and is much accurate as compared to reduced order model.

## 3.2 Framework:-

In DCM, in addition to two modes as in CCM, there is a third mode of operation in which capacitor voltage or inductor current is zero. For DCM operation, during first interval (i.e. ON period) the switch is turned on and inductor current rises and reached a peak when the switch is about to turn off, and resets to zero at the end of the OFF period.

$d_1 T_S = \text{ON Period time}$

$d_2 T_S = \text{OFF Period time}$

$T_S = \text{Total time period for one cycle}$

$i_{pk} = \text{peak value of inductor current after ON period}$

$\bar{i}_L = \text{Average value of current}$

$V_{in} = \text{input voltage}$

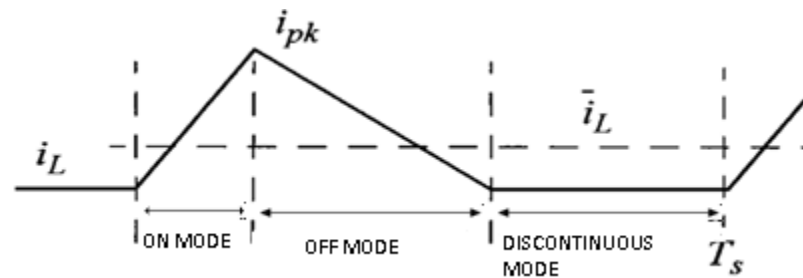

Figure 3.1

Thus,

$$\text{'ON' Mode } \dot{x} = A_1 x + B_1 v_{in} \quad \text{for } t \in [0, d_1 T_S] \quad \text{-(1)}$$

$$\text{'OFF' Mode } \dot{x} = A_2 x + B_2 v_{in} \quad \text{for } t \in [d_1 T_S, (d_1 + d_2) T_S] \quad \text{-(2)}$$

$$\text{'DC' Mode } \dot{x} = A_3 x + B_3 v_{in} \quad \text{for } t \in [(d_1 + d_2) T_S, T_S] \quad \text{-(3)}$$

*Note:* The duty ratio,  $d_2$ , is algebraically dependent on control and state variable. This dependency is defined in terms of average values of current and voltage. That way we can eliminate  $d_2$  from state variables and get a model which can be expressed in averaged state variables. The function which is describing this dependency is normally termed as the '*duty-ratio-constraint*'.

The modelling method for DCM operation comprises of three steps:

- a) Averaging;
- b) Inductor current analysis;
- c) Duty-ratio constraint.

State space averaging techniques are employed to get a set of equations that describe the system over one switching period. After applying averaging technique to equations (1)-(3), we get the following expression:-

$$\dot{\bar{X}} = [A_1 d_1 + A_2 d_2 + A_3(1 - d_1 - d_2)]\bar{X} + [B_1 d_1 + B_2 d_2 + B_3(1 - d_1 - d_2)]u \quad (4)$$

The above equation can be written as  $\dot{\bar{X}} = A \bar{X} + B u$ , where,

$$A = [A_1 d_1 + A_2 d_2 + A_3(1 - d_1 - d_2)] \text{ and } B = B_1 d_1 + B_2 d_2 + B_3(1 - d_1 - d_2).$$

In state space averaging technique in DCM, we are averaging only the matrix parameter and not the state variables. Equation (4) will hold good when we use true average of every state variable.

From figure 3.1, it can be deduced that average is:-

$$\bar{i}_L = \frac{i_{pk}}{2} \cdot (d_1 + d_2) \quad (5)$$

Consider when switch is 'on', the current which is delivered to capacitor is not necessarily having the same value as average inductor current. As inductor current charges rapidly with time, it is quite easy to derive the capacitor equation with the help of 'conservation of charge' principle, and after that averaging step is performed. The total amount of charge which capacitor obtains from the inductor during switching cycle is:-

$$Q_C = \frac{i_{pk} d_1 T_S}{2}$$

Thus average charging current would be of value:-

$$\frac{Q_C}{T_S} = \frac{i_{pk} d_1}{2} \quad (6)$$

When a capacitor is connected to resistive load, then the net charge which is delivered to the capacitor is given by :

$$\left(\frac{i_{pk}d_1}{2}\right) - \frac{v_C}{R}.$$

On the average

$$C \frac{dv_C}{dt} = \frac{i_{pk}d_1}{2} - \frac{v_C}{R}$$

Note here that the above expression differs from the Kirchhoff Current Law expression of capacitor which is obtained through state-space averaging. From model (4), we can define state-space-averaged (SSA) charging current as the inductor current's average multiplied with duty ratio for which inductor is charging the capacitor. From (5), the SSA charging current can be expressed as:-

$$\bar{i}_L d_1 = \frac{i_{pk}d_1}{2} \cdot (d_1 + d_2) \quad - (7)$$

This expression is different from actual charging current in (6). It can be implied that a 'charge conservation' law is violated in unmodified SSA as the averaging step is done on complete model thus leading to un matching of responses with averaged response of dc-dc converters. Thus (4) is modified by dividing by factor of  $d_1 + d_2$  the inductor current. The basic method is to rearrange the x, thus  $x = [i_L v_C]^T$ , where all inductor currents ( $n_L$ ) are contained in  $i_L$  and define a matrix K, as below:

$$K = \text{diag} \left[ \frac{1}{d_1 + d_2}, \dots, \frac{1}{d_1 + d_2}, 1, 1, 1 \dots \dots, 1 \right]$$

With this correction vector, the averaged modified model becomes

$$\bar{X} = [A_1 d_1 + A_2 d_2 + A_3 (1 - d_1 - d_2)] K \bar{x} + [B_1 d_1 + B_2 d_2 + B_3 (1 - d_1 - d_2)] v_{in} \quad - (8)$$

For a Buck Converter,

$$A_1 = \begin{bmatrix} 0 & -\frac{1}{L} \\ \frac{1}{C} & -\frac{1}{RC} \end{bmatrix}, A_2 = \begin{bmatrix} 0 & -\frac{1}{L} \\ \frac{1}{C} & -\frac{1}{RC} \end{bmatrix}, A_3 = \begin{bmatrix} 0 & 0 \\ 0 & -\frac{1}{RC} \end{bmatrix},$$

$$B_1 = \begin{bmatrix} \frac{1}{L} \\ 0 \end{bmatrix}, B_2 = \begin{bmatrix} 0 \\ 0 \end{bmatrix}, B_3 = \begin{bmatrix} 0 \\ 0 \end{bmatrix}.$$

The state space averaged model for the above equation is

$$\frac{d}{dt} \begin{bmatrix} \bar{i}_L \\ \bar{v}_C \end{bmatrix} = \begin{bmatrix} 0 & -\frac{(d_1+d_2)}{L} \\ \frac{(d_1+d_2)}{C} & -\frac{1}{RC} \end{bmatrix} \begin{bmatrix} \bar{i}_L \\ \bar{v}_C \end{bmatrix} + \begin{bmatrix} \frac{d_1}{L} \\ 0 \end{bmatrix} v_{in}.$$

Since in this model only one inductor is involved plus with x's dimension is two, the modification matrix denoted by K is simply given as:

$$K = \begin{bmatrix} \frac{1}{d_1+d_2} & 0 \\ 0 & 1 \end{bmatrix}.$$

Thus the resulted averaged model after modification will be given by:

$$\begin{aligned} \frac{d}{dt} \begin{bmatrix} \bar{i}_L \\ \bar{v}_C \end{bmatrix} &= \begin{bmatrix} 0 & -\frac{(d_1+d_2)}{L} \\ \frac{(d_1+d_2)}{C} & -\frac{1}{RC} \end{bmatrix} K \begin{bmatrix} \bar{i}_L \\ \bar{v}_C \end{bmatrix} + \begin{bmatrix} \frac{d_1}{L} \\ 0 \end{bmatrix} v_{in} \\ &= \begin{bmatrix} 0 & -\frac{(d_1+d_2)}{L} \\ \frac{1}{C} & -\frac{1}{RC} \end{bmatrix} \begin{bmatrix} \bar{i}_L \\ \bar{v}_C \end{bmatrix} + \begin{bmatrix} \frac{d_1}{L} \\ 0 \end{bmatrix} v_{in}. \quad - (9) \end{aligned}$$

For a Boost Converter,

$$A_1 = \begin{bmatrix} 0 & 0 \\ 0 & -\frac{1}{RC} \end{bmatrix}, A_2 = \begin{bmatrix} 0 & -\frac{1}{L} \\ \frac{1}{C} & -\frac{1}{RC} \end{bmatrix}, A_3 = \begin{bmatrix} 0 & 0 \\ 0 & -\frac{1}{RC} \end{bmatrix},$$

$$B_1 = \begin{bmatrix} \frac{1}{L} \\ 0 \end{bmatrix}, B_2 = \begin{bmatrix} \frac{1}{L} \\ 0 \end{bmatrix}, B_3 = \begin{bmatrix} 0 \\ 0 \end{bmatrix}.$$

The state space averaged model for the above equation is

$$\frac{d}{dt} \begin{bmatrix} \bar{i}_L \\ \bar{v}_C \end{bmatrix} = \begin{bmatrix} 0 & -\frac{d_2}{L} \\ \frac{d_2}{C} & -\frac{1}{RC} \end{bmatrix} \begin{bmatrix} \bar{i}_L \\ \bar{v}_C \end{bmatrix} + \begin{bmatrix} \frac{d_1+d_2}{L} \\ 0 \end{bmatrix} v_{in}.$$

As we can see only one inductor is there and the x is having dimension two, the modification matrix K is simply.

$$K = \begin{bmatrix} \frac{1}{d_1+d_2} & 0 \\ 0 & 1 \end{bmatrix}.$$

Thus modified averaged model of boost converter in DCM would be like below:-

$$\begin{aligned} \frac{d}{dt} \begin{bmatrix} \bar{i}_L \\ \bar{v}_C \end{bmatrix} &= \begin{bmatrix} 0 & -\frac{d_2}{L} \\ \frac{d_2}{C} & -\frac{1}{RC} \end{bmatrix} K \begin{bmatrix} \bar{i}_L \\ \bar{v}_C \end{bmatrix} + \begin{bmatrix} \frac{d_1+d_2}{L} \\ 0 \end{bmatrix} v_{in} \\ &= \begin{bmatrix} 0 & -\frac{d_2}{L} \\ \frac{d_2}{C(d_1+d_2)} & -\frac{1}{RC} \end{bmatrix} \begin{bmatrix} \bar{i}_L \\ \bar{v}_C \end{bmatrix} + \begin{bmatrix} \frac{d_1+d_2}{L} \\ 0 \end{bmatrix} v_{in}. \quad - (10) \end{aligned}$$

### 3.3 Reduced Order Model:-

To complete the averaged model (8), a duty ratio constraint is defined showing the dependency of  $d_2$  on other variables. Usually in conventional state-space averaging technique [3], inductor's voltage balance eqn. is used in defining duty-ratio constraint.

For the buck topology, utilizing the volt second balance over the switching cycle,

$$v_L = L \frac{di}{dt}$$

$$di = \frac{v_L dt}{L}$$

$$\text{For time, } T_1 = d_1 T_s, \quad I_{max} - 0 = \frac{V_{in} - V_C}{L} T_1;$$

$$\text{For Time, } T_2 = d_2 T_s, \quad 0 - I_{max} = \frac{-V_C}{L} T_2;$$

By removing  $I_{max}$  from above equations,

$$I_{max} = \frac{V_{in} - V_C}{L} d_1 T_s = \frac{V_C}{L} d_2 T_s$$

$$(V_{in} - V_C) d_1 = V_C d_2$$

$$d_2 = \frac{(V_{in} - V_C) d_1}{V_C} \quad - (11)$$

Similarly for Boost Converter,

$$\text{For time, } T_1 = d_1 T_s,$$

$$I_{max} - 0 = \frac{V_{in}}{L} T_1;$$

$$\text{For Time, } T_2 = d_2 T_s$$

$$0 - I_{max} = \frac{V_{in} - V_C}{L} T_2;$$

By removing  $I_{max}$  from above equations,

$$I_{max} = \frac{V_{in}}{L} d_1 T_s = \frac{V_C - V_{in}}{L} d_2 T_s$$

$$V_{in} d_1 = (V_C - V_{in}) d_2$$

$$d_2 = \frac{v_{in}}{v_C - v_{in}} d_1 \quad - (12)$$

For Buck Converter, Substituting  $d_2$  from (11) in equation (9), we get

$$\frac{d\bar{i}_L}{dt} = 0 \quad - (13)$$

$$\frac{d\bar{v}_C}{dt} = \frac{\bar{i}_L}{C} - \frac{\bar{v}_C}{RC} \quad - (14)$$

Similarly for Boost Converter, Substituting  $d_2$  in equation (10), we get

$$\frac{d\bar{i}_L}{dt} = 0 \quad - (15)$$

$$\frac{d\bar{v}_C}{dt} = \frac{V_{in}}{V_C} \frac{\bar{i}_L}{C} - \frac{\bar{V}_C}{RC} \quad - (16)$$

From these calculations for buck and boost converters, it can be seen that inductor current dynamics disappear thus resulting into degenerate model. Since inductor current is not present in state variable in this reduced order model, it must be replaced by expressing it as an algebraic function of other variables, so that inductor dynamics is removed.

For a buck converter, peak of inductor current is given by,

$$i_{pk} = \frac{v_{in} - v_C}{L} d_1 T_s \quad - (16)$$



Average of inductor current is given by,

$$\begin{aligned}\bar{i}_L &= \frac{i_{pk}}{2}(d_1 + d_2) \\ &= \frac{(v_{in}-v_C)(d_1+d_2)d_1T_S}{2L} \quad - (17)\end{aligned}$$

Substituting (17), the above relation (14) can be written as

$$\bar{i}_L = \left(\frac{v_{in} - v_C}{2L}\right) \left(\frac{v_{in}}{v_C}\right) d_1^2 T_S \quad - (18)$$

For a boost converter, peak of inductor current is given by,

$$i_{pk} = \frac{v_{in}}{L} d_1 T_S \quad - (19)$$

Average of inductor current is given by,

$$\begin{aligned}\bar{i}_L &= \frac{i_{pk}}{2}(d_1 + d_2) \\ &= \frac{v_{in}}{2L} d_1(d_1 + d_2) T_S \quad - (20)\end{aligned}$$

Substituting (20), the above relation can be written as

$$\bar{i}_L = \frac{v_{in}}{2L} \frac{d_1^2 T_S \bar{v}_C}{\bar{v}_C - v_{in}} \quad - (21)$$

$\bar{i}_L$  from (18) can be replaced into (14) to give CONVENTIONAL AVERAGED MODEL for BUCK CONVERTER in DCM [3], to remove dependency on  $\bar{i}_L$ .

$$\frac{d\bar{v}_C}{dt} = \frac{v_{in}}{2LC} \frac{(v_{in} - \bar{v}_C)}{\bar{v}_C} d^2 T_S - \frac{\bar{v}_C}{RC} \quad - (22)$$

Similarly for Boost Converter, the model will be obtained by replacing (21) into (16)

$$\frac{d\bar{v}_C}{dt} = \frac{v_{in}^2}{2LC} \frac{d^2 T_S}{\bar{v}_C - v_{in}} - \frac{\bar{v}_C}{RC} \quad - (23)$$

## Reduced Order Averaged Model for Buck Converter

Now apply standard linearization technique and apply perturbations as follows to (22):-

$$\begin{aligned}\bar{i}_L &= I_L + \tilde{i}_L; \\ \bar{v}_C &= V_C + \tilde{v}_C; \\ v_{in} &= V_{in} + \tilde{v}_{in}; \\ d &= D + \tilde{d};\end{aligned}$$

$$\frac{d(V_C + \tilde{v}_C)}{dt} = \frac{(V_{in} + \tilde{v}_{in})}{2LC} \frac{(V_{in} + \tilde{v}_{in} - V_C - \tilde{v}_C)}{(V_C + \tilde{v}_C)} (D + d)^2 T_S - \frac{(V_C + \tilde{v}_C)}{RC}$$

$$\begin{aligned}2RLC(V_C + \tilde{v}_C) \frac{d\tilde{v}_C}{dt} \\ = R(V_{in} + \tilde{v}_{in})(V_{in} + \tilde{v}_{in} - V_C - \tilde{v}_C)(D + d)^2 T_S - 2L(V_C + \tilde{v}_C)^2\end{aligned}$$

Separating terms of  $\tilde{i}_L$ ,  $\tilde{v}_C$ ,  $\tilde{v}_{in}$  and  $\tilde{d}$ , and converting it to state space form,

$$\begin{bmatrix} \dot{\tilde{i}}_L \\ \dot{\tilde{v}}_C \end{bmatrix} = \begin{bmatrix} 0 & 0 \\ 0 & -RV_{in}D^2T_S \end{bmatrix} \begin{bmatrix} \tilde{i}_L \\ \tilde{v}_C \end{bmatrix} + \begin{bmatrix} 0 & 0 \\ R(V_{in} - V_C)D^2T_S & RV_{in}(V_{in} - V_C)2DT_S \end{bmatrix} \begin{bmatrix} \tilde{v}_{in} \\ \tilde{d} \end{bmatrix}$$

Which is in the form of:-

$$\frac{d}{dt} \begin{bmatrix} \tilde{i}_L \\ \tilde{v}_C \end{bmatrix} = \mathbf{A} \begin{bmatrix} \tilde{i}_L \\ \tilde{v}_C \end{bmatrix} + \mathbf{B} \begin{bmatrix} \tilde{v}_{in} \\ \tilde{d} \end{bmatrix}$$

$$\text{Then, } \begin{bmatrix} \tilde{i}_L(s) \\ \tilde{v}_C(s) \end{bmatrix} = \tilde{\mathbf{X}}(s) = (s\mathbf{I} - \mathbf{A})^{-1} \mathbf{B} \mathbf{U}(s)$$

$$\text{Where, } (s\mathbf{I} - \mathbf{A})^{-1} = \left\{ \begin{bmatrix} s & 0 \\ 0 & s \end{bmatrix} - \begin{bmatrix} 0 & 0 \\ 0 & -RV_{in}D^2T_S \end{bmatrix} \right\}^{-1}$$

$$= \frac{1}{\Delta} \begin{bmatrix} s + (4V_C L + RV_{in}D^2T_S) & 0 \\ 0 & s \end{bmatrix} \text{ where, } \frac{1}{\Delta} = \frac{1}{s^2 + s(4V_C L + RV_{in}D^2T_S)}$$

$$\begin{bmatrix} \widetilde{i_L(s)} \\ \widetilde{v_C(s)} \end{bmatrix} = \frac{1}{\Delta} \begin{bmatrix} s + (4V_C L + R V_{in} D^2 T_S) & 0 \\ 0 & s \end{bmatrix} \begin{bmatrix} 0 & 0 \\ R(V_{in} - V_C) D^2 T_S & R V_{in} (V_{in} - V_C) 2 D T_S \end{bmatrix} \begin{bmatrix} \widetilde{v_{in}(s)} \\ \widetilde{d(s)} \end{bmatrix}$$

$$\begin{bmatrix} \widetilde{i_L(s)} \\ \widetilde{v_C(s)} \end{bmatrix} = \begin{bmatrix} 0 & 0 \\ s R(V_{in} - V_C) D^2 T_S & s R V_{in} (V_{in} - V_C) 2 D T_S \end{bmatrix} \cdot \begin{bmatrix} \widetilde{v_{in}(s)} \\ \widetilde{d(s)} \end{bmatrix} \cdot \frac{1}{\Delta}$$

Thus, two transfer functions are as follows:-

$$\frac{\widetilde{v_C(s)}}{\widetilde{v_{in}(s)}} = \frac{s R(V_{in} - V_C) D^2 T_S}{\Delta}$$

And,

$$\frac{\widetilde{v_C(s)}}{\widetilde{d(s)}} = \frac{s R V_{in} (V_{in} - V_C) D^2 T_S}{\Delta}$$

## Reduced Order Averaged Model for Boost Converter

Similarly, apply standard linearization technique and apply perturbations as follows to (23):-

$$\begin{aligned} \bar{i}_L &= I_L + \widetilde{i}_L; \\ \bar{v}_C &= V_C + \widetilde{v}_C; \\ v_{in} &= V_{in} + \widetilde{v}_{in}; \\ d &= D + \widetilde{d}; \end{aligned}$$

$$\frac{d(V_C + \widetilde{v}_C)}{dt} = \frac{(V_{in} + \widetilde{v}_{in})^2}{2LC} \frac{(D + \widetilde{d})^2 T_S}{(V_C + \widetilde{v}_C - V_{in} - \widetilde{v}_{in})} - \frac{(V_C + \widetilde{v}_C)}{RC}$$

$$\begin{aligned}
 2RLC(V_C - V_{in}) \frac{d\widetilde{v}_C}{dt} \\
 = R(V_{in}^2 + 2V_{in}\widetilde{v}_{in})(D^2 + 2Dd)T_S - 2L(V_C + \widetilde{v}_C)(V_C + \widetilde{v}_C - V_{in} \\
 - \widetilde{v}_{in})
 \end{aligned}$$

Separating terms of  $\widetilde{i}_L$ ,  $\widetilde{v}_C$ ,  $\widetilde{v}_{in}$  and  $\widetilde{d}$ , and converting it to state space form,

$$\begin{aligned}
 \begin{bmatrix} \dot{\widetilde{i}}_L \\ \dot{\widetilde{v}}_C \end{bmatrix} = \begin{bmatrix} 0 & 0 \\ 0 & -\frac{1}{RC} \left( \frac{2M-1}{M-1} \right) \end{bmatrix} \begin{bmatrix} \widetilde{i}_L \\ \widetilde{v}_C \end{bmatrix} \\
 + \begin{bmatrix} 0 & 0 \\ \frac{D^2T_S}{LC(M-1)} + \frac{M}{RC(M-1)} & \frac{DT_S V_{in}}{LC(M-1)} \end{bmatrix} \begin{bmatrix} \widetilde{v}_{in} \\ \widetilde{d} \end{bmatrix}
 \end{aligned}$$

Which is in the form of:-  $\frac{d}{dt} \begin{bmatrix} \widetilde{i}_L \\ \widetilde{v}_C \end{bmatrix} = \mathbf{A} \begin{bmatrix} \widetilde{i}_L \\ \widetilde{v}_C \end{bmatrix} + \mathbf{B} \begin{bmatrix} \widetilde{v}_{in} \\ \widetilde{d} \end{bmatrix}$

Then,  $\begin{bmatrix} \widetilde{i}_L(s) \\ \widetilde{v}_C(s) \end{bmatrix} = \widetilde{X}(s) = (s\mathbf{I} - \mathbf{A})^{-1} \mathbf{B} \mathbf{U}(s)$

$$\begin{aligned}
 \text{Where, } (s\mathbf{I} - \mathbf{A})^{-1} &= \left\{ \begin{bmatrix} s & 0 \\ 0 & s \end{bmatrix} - \begin{bmatrix} 0 & 0 \\ 0 & -\frac{1}{RC} \left( \frac{2M-1}{M-1} \right) \end{bmatrix} \right\}^{-1} \\
 &= \frac{1}{\Delta} \begin{bmatrix} s + \frac{1}{RC} \left( \frac{2M-1}{M-1} \right) & 0 \\ 0 & s \end{bmatrix} \text{ Where, } \frac{1}{\Delta} = \frac{1}{s^2 + s \left[ \frac{1}{RC} \left( \frac{2M-1}{M-1} \right) \right]}
 \end{aligned}$$

$$\begin{bmatrix} \widetilde{i}_L(s) \\ \widetilde{v}_C(s) \end{bmatrix} = \frac{1}{\Delta} \begin{bmatrix} s + \frac{1}{RC} \left( \frac{2M-1}{M-1} \right) & 0 \\ 0 & s \end{bmatrix} \begin{bmatrix} 0 & 0 \\ \frac{D^2T_S}{LC(M-1)} + \frac{M}{RC(M-1)} & \frac{DT_S V_{in}}{LC(M-1)} \end{bmatrix} \begin{bmatrix} \widetilde{v}_{in}(s) \\ \widetilde{d}(s) \end{bmatrix}$$

$$\begin{bmatrix} \widetilde{i}_L(s) \\ \widetilde{v}_C(s) \end{bmatrix} = \begin{bmatrix} 0 & 0 \\ s \left( \frac{D^2T_S}{LC(M-1)} + \frac{M}{RC(M-1)} \right) & s \left( \frac{DT_S V_{in}}{LC(M-1)} \right) \end{bmatrix} \cdot \begin{bmatrix} \widetilde{v}_{in}(s) \\ \widetilde{d}(s) \end{bmatrix} \cdot \frac{1}{\Delta}$$

Thus, two transfer functions are as follows:-

$$\frac{\widetilde{v}_C(s)}{\widetilde{v}_{in}(s)} = \frac{s \left( \frac{D^2T_S}{LC(M-1)} + \frac{M}{RC(M-1)} \right)}{\Delta}$$

And,

$$\frac{\widetilde{v_c(s)}}{\widetilde{d(s)}} = \frac{s \left( \frac{DT_s V_{in}}{LC(M-1)} \right)}{\Delta}$$

**Control transfer function:**

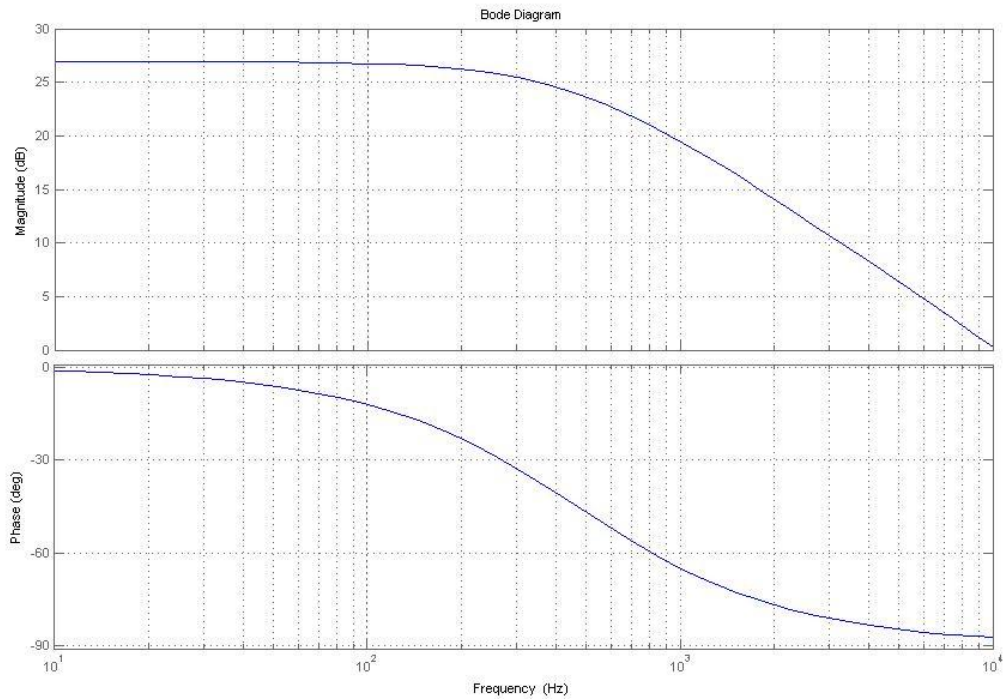

### **3.4 NEW FULL ORDER AVERAGED MODELS:-**

Limitations of Reduced order model is that although it can correctly predict dc and low frequency behaviour of PWM converters, at high frequencies, it is unable to capture the dynamics of boost and buck converter. Full-order models however can very well predict the high-frequency responses and are therefore desired.

#### **MODEL DERIVATION :-**

For Buck Converter:-

The New Full order derivation starts from modified averaged model (8). This model differs from reduced one in terms of duty ratio constraint. From (16), we can get this relation:-

$$i_{pk} = \frac{v_{in} - v_C}{L} d_1 T_S$$

From (5)

$$\bar{i}_L = \frac{i_{pk}}{2} (d_1 + d_2)$$

Substituting  $i_{pk}$  into this, we get duty constraint

$$d_2 = \frac{L \bar{i}_L}{d_1 T_S (v_{in} - v_C)} - d_1$$

This constraint is different from the earlier one which is derived for reduced order model showing that it enforces correct average charging of output capacitor. Putting  $d_2$  into (9), these relations are derived:-

$$\frac{d\bar{i}_L}{dt} = \frac{d_1 v_{in}}{L} - \frac{2\bar{i}_L \bar{v}_C}{d_1 T_S (v_{in} - \bar{v}_C)} \quad - (24)$$

$$\frac{d\bar{v}_C}{dt} = \frac{\bar{i}_L}{C} - \frac{\bar{v}_C}{RC} \quad - (25)$$

## DC analysis:

The dc operating point can be determined by

$$\frac{d\bar{i}_L}{dt} = 0$$

And

$$\frac{d\bar{v}_C}{dt} = 0$$

Let  $G = \frac{\bar{v}_C}{V_{in}}$

From (24) and (25)

$$\bar{I}_L = \frac{G V_{in}}{R} \quad - (26)$$

$$G = \frac{-RD^2T_s + \sqrt{R^2D^4T_s^2 - 8RD^2T_sL}}{4L} \quad -(27)$$

Now apply standard linearization technique and apply perturbations as follows to (24) and (25):-

$$\begin{aligned} \bar{i}_L &= I_L + \tilde{i}_L; \\ \bar{v}_C &= V_C + \tilde{v}_C; \\ v_{in} &= V_{in} + \tilde{v}_{in}; \\ d_1 &= D + \tilde{d}; \end{aligned}$$

Thus,

$$\frac{d(I_L + \tilde{i}_L)}{dt} = \frac{(D + d)(V_{in} + \tilde{v}_{in})}{L} - 2 \frac{(I_L + \tilde{i}_L)(V_C + \tilde{v}_C)}{(D + \tilde{d})T_s(V_{in} + \tilde{v}_{in} - V_C - \tilde{v}_C)}$$

$$\begin{aligned} LDT_s(V_{in} - V_C) \frac{d\tilde{i}_L}{dt} \\ = (D + d)^2T_s(V_{in} + \tilde{v}_{in})(V_{in} + \tilde{v}_{in} - V_C - \tilde{v}_C) - 2L(I_L + \tilde{i}_L)(V_C \\ + \tilde{v}_C) \end{aligned}$$

Also,

$$\begin{aligned} \frac{d(V_C + \tilde{v}_C)}{dt} &= \frac{(I_L + \tilde{i}_L)}{C} - \frac{(V_C + \tilde{v}_C)}{RC} \\ \frac{d\tilde{v}_C}{dt} &= \frac{\tilde{i}_L}{C} - \frac{\tilde{v}_C}{RC} \end{aligned}$$

Small Signal Model can be derived to following equation

$$\frac{d}{dt} \begin{bmatrix} \tilde{i}_L \\ \tilde{v}_C \end{bmatrix} = A \begin{bmatrix} \tilde{i}_L \\ \tilde{v}_C \end{bmatrix} + B \begin{bmatrix} \tilde{v}_{in} \\ \tilde{d} \end{bmatrix}$$

Where

$$A = \begin{bmatrix} \frac{2M}{DT_s(M-1)} & \frac{DV_{in}}{L(M-1)} - \frac{2I_L}{DT_s(1-M)V_{in}} \\ \frac{1}{C} & \frac{-1}{RC} \end{bmatrix}, B = \begin{bmatrix} \frac{D}{L} - \frac{D}{L(1-M)} & \frac{2V_{in}}{L} \\ 0 & 0 \end{bmatrix}.$$

$$\text{Then, } \begin{bmatrix} \tilde{i}_L(s) \\ \tilde{v}_C(s) \end{bmatrix} = \tilde{X}(s) = (sI - A)^{-1} B U(s)$$

$$\begin{aligned}
 (sI - A)^{-1} &= \left\{ \begin{bmatrix} s & 0 \\ 0 & s \end{bmatrix} - \begin{bmatrix} \frac{2M}{DT_s(M-1)} & \frac{DV_{in}}{L(M-1)} - \frac{2I_L}{DT_s(1-M)V_{in}} \\ \frac{1}{C} & \frac{-1}{RC} \end{bmatrix} \right\}^{-1} \\
 &= \frac{1}{\Delta} \begin{bmatrix} s + \frac{1}{RC} & \frac{D}{L(M-1)} - \frac{2I_L}{DT_s V_{in}(1-M)} \\ \frac{1}{C} & s + \frac{2M}{DT_s(1-M)} \end{bmatrix}
 \end{aligned}$$

$$\text{Where, } \frac{1}{\Delta} = \frac{1}{s^2 + s \left( \frac{1}{RC} + \frac{2M}{DT_s(1-M)} \right) + \frac{2M}{DT_s RC(1-M)} + \frac{D}{LC(1-M)} + \frac{2I_L}{DT_s V_{in} C(1-M)}}$$

$$\begin{bmatrix} \widetilde{i_L(s)} \\ \widetilde{v_C(s)} \end{bmatrix} = \frac{1}{\Delta} \begin{bmatrix} s + \frac{1}{RC} & \frac{D}{L(M-1)} - \frac{2I_L}{DT_s V_{in}(1-M)} \\ \frac{1}{C} & s + \frac{2M}{DT_s(1-M)} \end{bmatrix} * \begin{bmatrix} \frac{D}{L} - \frac{D}{L(1-M)} & \frac{2V_{in}}{L} \\ 0 & 0 \end{bmatrix} * \begin{bmatrix} \widetilde{v_{in}(s)} \\ \widetilde{d(s)} \end{bmatrix}$$

$$\begin{bmatrix} \widetilde{i_L(s)} \\ \widetilde{v_C(s)} \end{bmatrix} = \begin{bmatrix} \left( s + \frac{1}{RC} \right) \left( \frac{D}{L} - \frac{D}{L(1-M)} \right) & s \frac{2V_{in}}{L} + \frac{2V_{in}}{RLC} \\ \frac{D}{LC} - \frac{D}{LC(1-M)} & \frac{2V_{in}}{LC} \end{bmatrix} * \begin{bmatrix} \widetilde{v_{in}(s)} \\ \widetilde{d(s)} \end{bmatrix} \cdot \frac{1}{\Delta}$$

Thus, Transfer functions can be formulated from small signal model to below equations

$$\frac{\widetilde{i_L(s)}}{\widetilde{v_{in}(s)}} = \left[ \left( s + \frac{1}{RC} \right) \left( \frac{D}{L} - \frac{D}{L(1-M)} \right) \right] \cdot \frac{1}{\Delta},$$

$$\frac{\widetilde{i_L(s)}}{\widetilde{d(s)}} = \left[ s \frac{2V_{in}}{L} + \frac{2V_{in}}{RLC} \right] \cdot \frac{1}{\Delta},$$

$$\frac{\widetilde{v_C(s)}}{\widetilde{v_{in}(s)}} = \left[ \frac{D}{LC} - \frac{D}{LC(1-M)} \right] \cdot \frac{1}{\Delta},$$

$$\frac{\widetilde{v_C(s)}}{\widetilde{d(s)}} = \left[ \frac{2V_{in}}{LC} \right] \cdot \frac{1}{\Delta}$$



By putting value of R,L,C ,T<sub>s</sub>,V<sub>g</sub> and using equation (26) and (27)

L=5μH, C=40μF ,f<sub>s</sub>=100kHz (T<sub>s</sub>=10μs) , V<sub>g</sub>=5V ,R=20Ω , D= 0.7

We Get

**(a)Inductor current to input voltage ratio**

$$\frac{\widetilde{i_L(s)}}{\widetilde{v_{in}(s)}} = \frac{S*1.8*10^6+2.25*10^9}{S^2+3.06*10^6S+47.62*10^9}$$

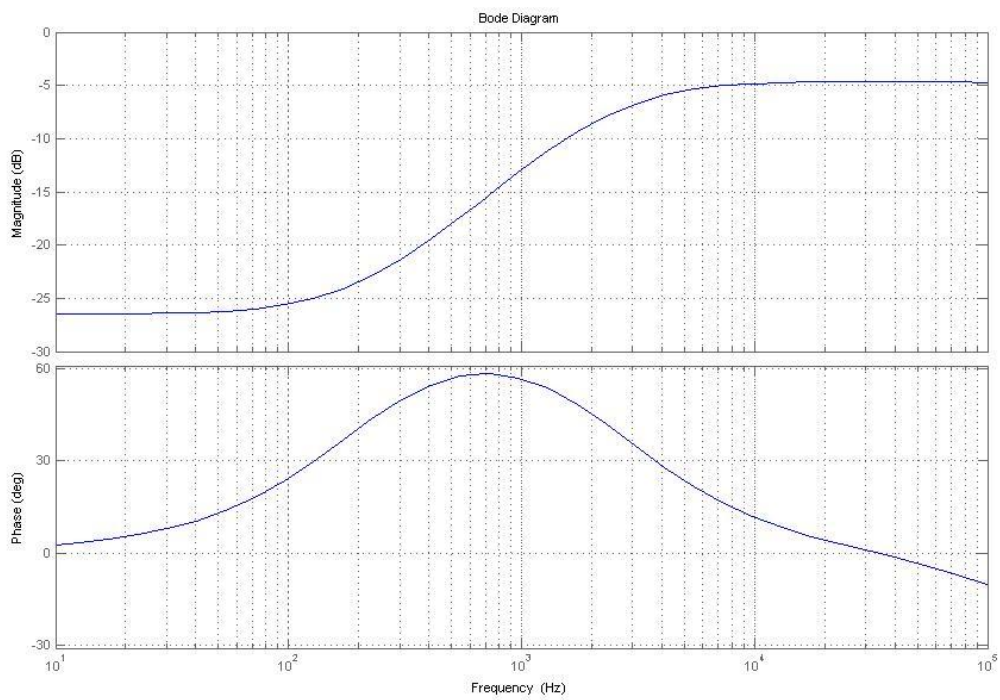

(a)

**(b)Inductor current to duty ratio:**

$$\frac{\widetilde{i_L(s)}}{\widetilde{d(s)}} = \frac{S*10^6+2.5*10^9}{S^2+3.06*10^6S+47.62*10^9}$$

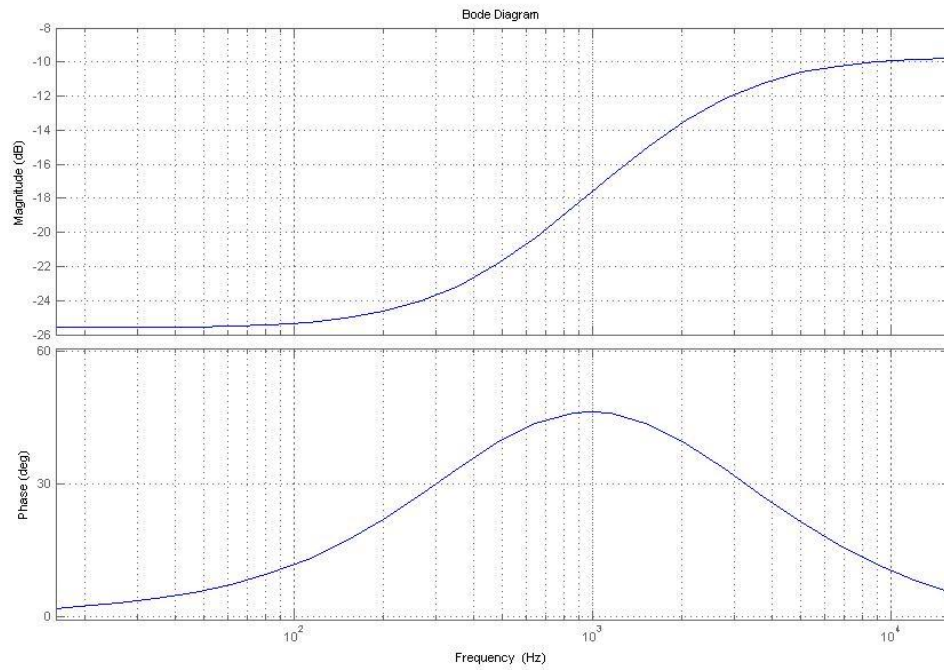

**(b)**

**(c) Audio susceptibility:**

$$\frac{\widetilde{v_C(s)}}{\widetilde{v_{in}(s)}} = \frac{44.45 \cdot 10^9}{S^2 + 3.06 \cdot 10^6 S + 47.62 \cdot 10^9}$$

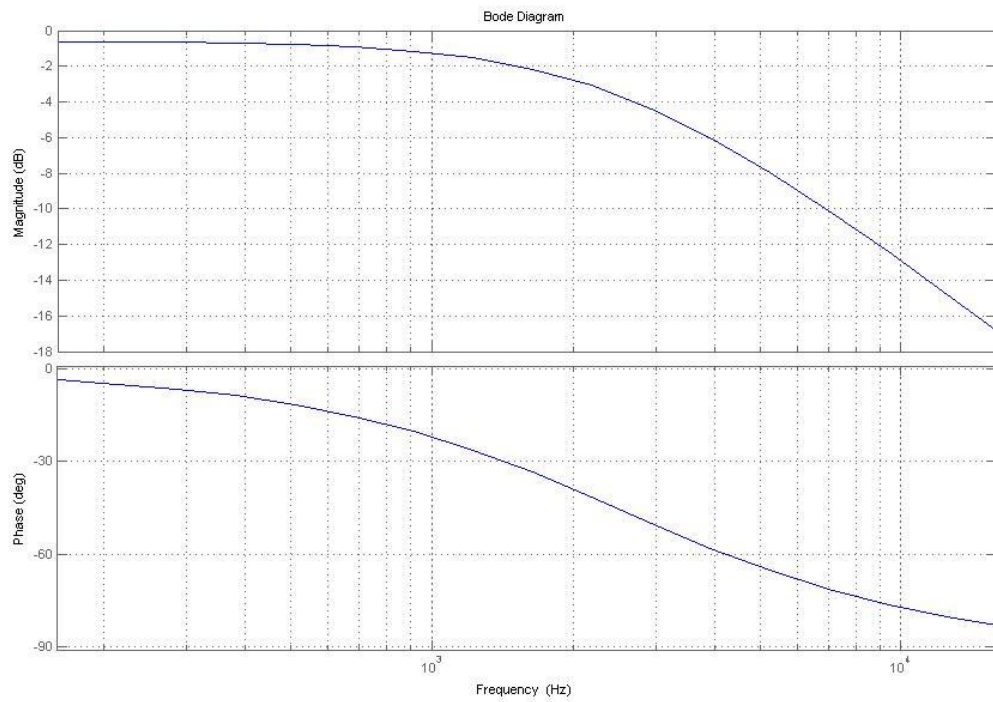

(c)

**(d)Control transfer function:**

$$\frac{\widehat{v}_C(s)}{\widehat{d}(s)} = \frac{50 \cdot 10^9}{s^2 + 3.06 \cdot 10^6 s + 47.62 \cdot 10^9}$$

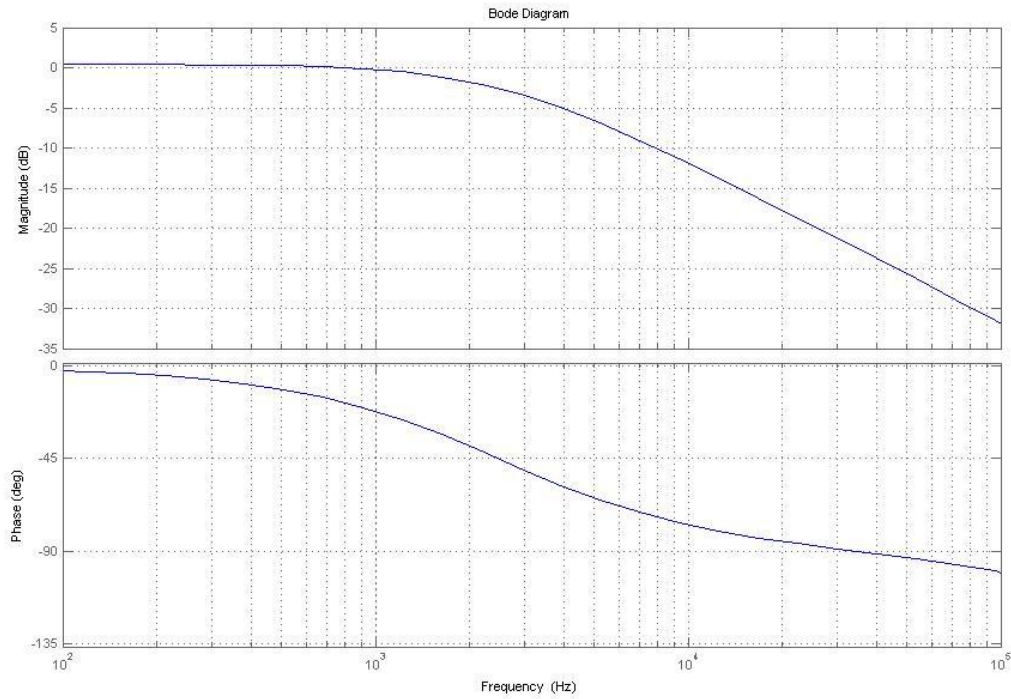

(d)

For Boost Converter:-

From (19), we can get this relation:-

$$i_{pk} = \frac{v_{in}}{L} d_1 T_S$$

Substituting this into (5), we get duty constraint

$$d_2 = \frac{2 L \bar{i}_L}{d_1 T_S v_{ON}} - d_1$$

Putting  $d_2$  into (10), these relations are derived:-

$$\frac{d\bar{i}_L}{dt} = \frac{2\bar{i}_L}{d_1 T_S} \left(1 - \frac{\bar{v}_C}{v_{in}}\right) + \frac{d_1 \bar{v}_C}{L} \quad - (28)$$

$$\frac{d\bar{v}_C}{dt} = \frac{\bar{i}_L}{C} - \frac{d_1^2 T_S v_{in}}{2LC} - \frac{\bar{v}_C}{RC} \quad - (29)$$



$$A = \begin{bmatrix} \frac{2(1-M)}{DT_s} & \frac{-D}{L(M-1)} \\ \frac{1}{C} & \frac{-1}{RC} \end{bmatrix}, B = \begin{bmatrix} \frac{DM^2}{L(M-1)} & \frac{2MV_{in}}{L} \\ \frac{-D^2T_s}{2LC} & \frac{-DT_sV_{in}}{LC} \end{bmatrix}.$$

$$\text{Then, } \begin{bmatrix} \widetilde{v_L(s)} \\ \widetilde{v_C(s)} \end{bmatrix} = \tilde{X}(s) = (sI - A)^{-1} B U(s)$$

$$(sI - A)^{-1} = \left\{ \begin{bmatrix} s & 0 \\ 0 & s \end{bmatrix} - \begin{bmatrix} \frac{2(1-M)}{DT_s} & \frac{-D}{L(M-1)} \\ \frac{1}{C} & \frac{-1}{RC} \end{bmatrix} \right\}^{-1}$$

$$= \frac{1}{\Delta} \begin{bmatrix} s + \frac{1}{RC} & \frac{-D}{L(M-1)} \\ \frac{1}{C} & s - \frac{2(1-M)}{DT_s} \end{bmatrix} \text{ Where, } \frac{1}{\Delta} = \frac{1}{s^2 + s\left(\frac{1}{RC} - \frac{2(1-M)}{D1Ts}\right) + \frac{2(2M-1)}{D1TsRC}}$$

$$\begin{bmatrix} \widetilde{v_L(s)} \\ \widetilde{v_C(s)} \end{bmatrix} = \frac{1}{\Delta} \begin{bmatrix} s + \frac{1}{RC} & \frac{-D}{L(M-1)} \\ \frac{1}{C} & s - \frac{2(1-M)}{DT_s} \end{bmatrix} \begin{bmatrix} \frac{DM^2}{L(M-1)} & \frac{2MV_{in}}{L} \\ \frac{-D^2T_s}{2LC} & \frac{-DT_sV_{in}}{LC} \end{bmatrix} \begin{bmatrix} \widetilde{v_{in}(s)} \\ \widetilde{d(s)} \end{bmatrix}$$

$$\begin{bmatrix} \widetilde{v_L(s)} \\ \widetilde{v_C(s)} \end{bmatrix} = \begin{bmatrix} \frac{sM^2}{L(M-1)} + \frac{M^2}{RLC(M-1)} + \frac{MD_1}{RLC} & \frac{s(2MV_{in})}{L} + \frac{2MV_{in}}{RLC} + \frac{2MV_{in}}{RLC} \\ \frac{M^2}{LC(M-1)} + \frac{D_1(1-M)}{LC} + \frac{s(-D^2T_s)}{2LC} & \frac{s(-D_1T_sV_{in})}{LC} + \frac{2MV_{in}}{LC} + \frac{2(1-M)V_{in}}{LC} \end{bmatrix} \cdot \frac{1}{\Delta} \begin{bmatrix} \widetilde{v_{in}(s)} \\ \widetilde{d(s)} \end{bmatrix}$$

$$\begin{bmatrix} \frac{s M^2}{L(M-1)} + \frac{M^2}{RLC(M-1)} + \frac{MD_1}{RLC} & \frac{s(2MV_{in})}{L} + \frac{2MV_{in}}{RLC} + \frac{2MV_{in}}{RLC} \\ \frac{M^2}{LC(M-1)} + \frac{D_1(1-M)}{LC} + \frac{s(-D^2T_S)}{2LC} & \frac{s(-D_1T_S V_{in})}{LC} + \frac{2MV_{in}}{LC} + \frac{2(1-M)V_{in}}{LC} \end{bmatrix} \cdot \begin{bmatrix} \widetilde{v_{in}(s)} \\ \widetilde{d(s)} \end{bmatrix} \cdot \frac{1}{\Delta}$$

Thus, Transfer functions can be formulated from small signal model to below equations

$$\frac{\widetilde{v_L(s)}}{\widetilde{v_{in}(s)}} = \left[ \frac{s M^2}{L(M-1)} + \frac{M^2}{RLC(M-1)} + \frac{MD_1}{RLC} \right] \cdot \frac{1}{\Delta},$$

$$\frac{\widetilde{v_L(s)}}{\widetilde{d(s)}} = \left[ \frac{s(2MV_{in})}{L} + \frac{2MV_{in}}{RLC} + \frac{2MV_{in}}{RLC} \right] \cdot \frac{1}{\Delta},$$

$$\frac{\widetilde{v_C(s)}}{\widetilde{v_{in}(s)}} = \left[ \frac{M^2}{LC(M-1)} + \frac{D_1(1-M)}{LC} + \frac{s(-D^2T_S)}{2LC} \right] \cdot \frac{1}{\Delta},$$

$$\frac{\widetilde{v_C(s)}}{\widetilde{d(s)}} = \left[ \frac{s(-D_1T_S V_{in})}{LC} + \frac{2MV_{in}}{LC} + \frac{2(1-M)V_{in}}{LC} \right] \cdot \frac{1}{\Delta}$$

Bode Plots :-

By putting  $L=5\mu\text{H}$ ,  $C=40\mu\text{F}$ ,  $f_s=100\text{kHz}$  ( $T_s=10\mu\text{s}$ ),  $V_g=5\text{V}$ ,  $R=20\Omega$ ,  $D=0.7$

## Inductor current to input voltage ratio

Bode Plot for  $\frac{i_L(s)}{v_{in}(s)}$

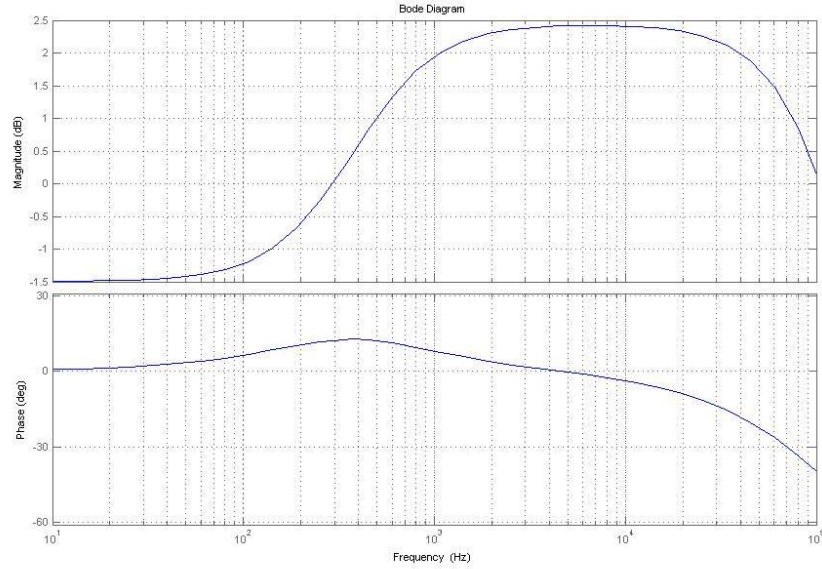

## Inductor current to input voltage

Bode Plot for  $\frac{i_L(s)}{d(s)}$

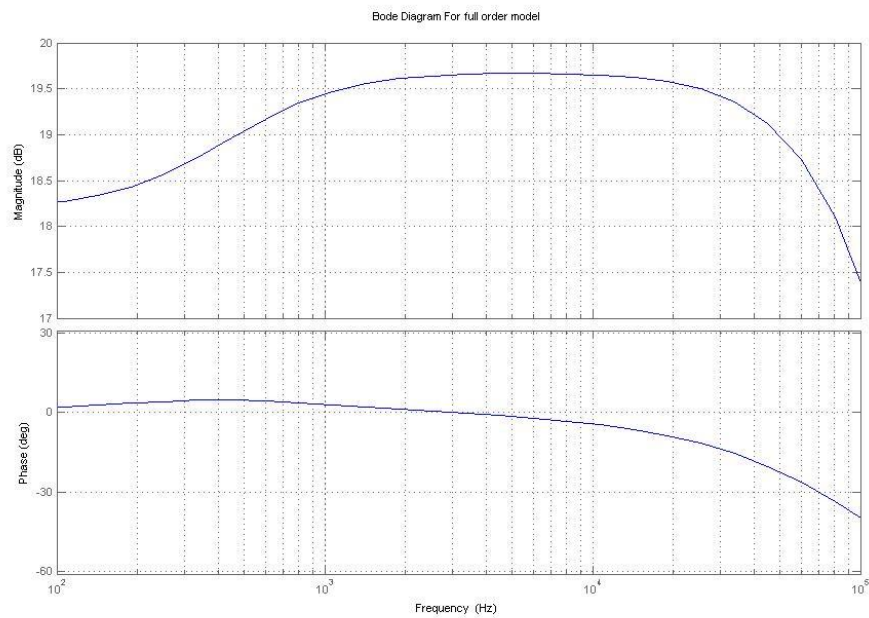



Audio susceptibility:

Bode Plot for  $\frac{Vc(s)}{Vin(s)}$

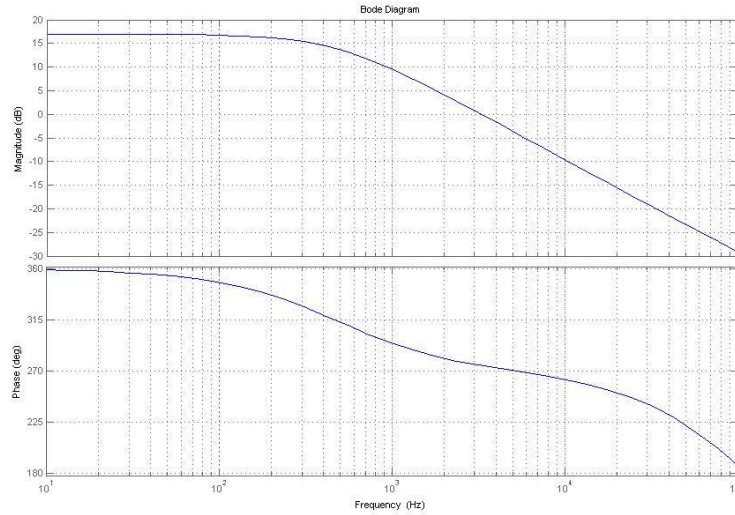

Control transfer function:

Bode plot for  $\frac{Vc(s)}{d(s)}$

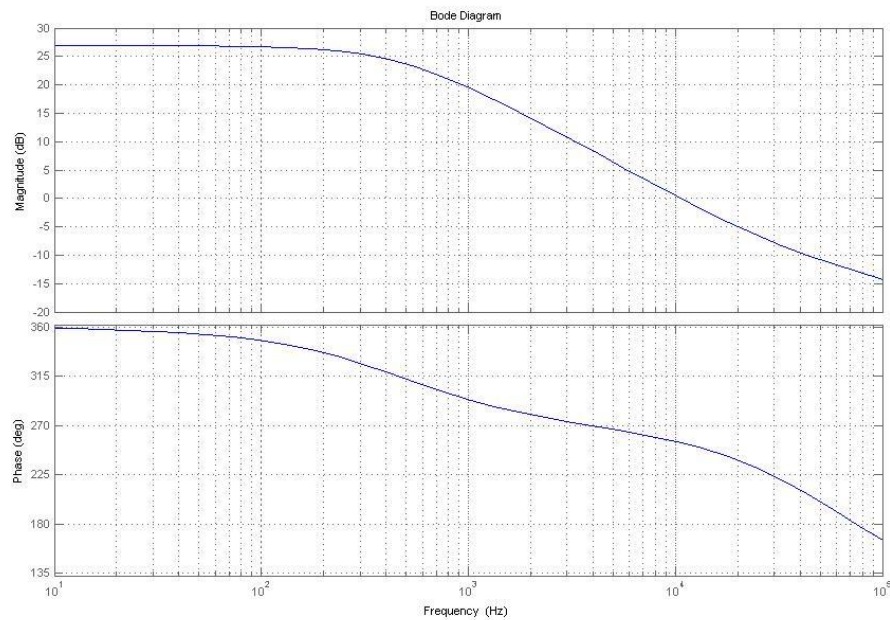

## Taking $I_{Load}$ in Boost Converter:

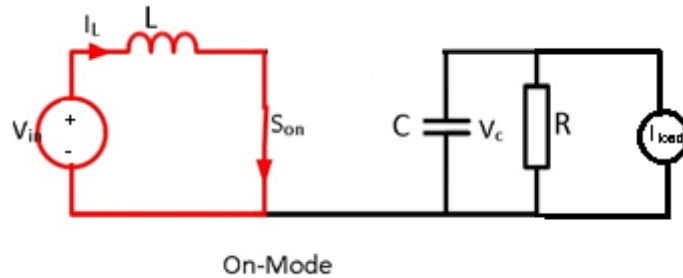

Figure 3.2

During ON Period:

$$A_1 = \begin{bmatrix} 0 & 0 \\ 0 & -\frac{1}{RC} \end{bmatrix}, B_1 = \begin{bmatrix} \frac{1}{L} & 0 \\ 0 & -\frac{1}{C} \end{bmatrix},$$

During OFF Period:

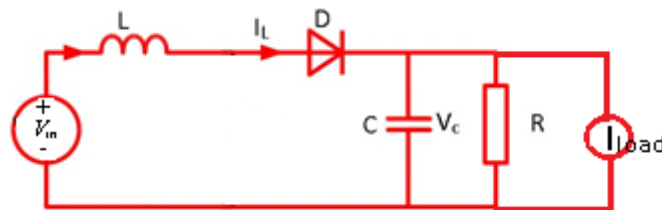

Figure 3.3

$$A_2 = \begin{bmatrix} 0 & -\frac{1}{L} \\ \frac{1}{C} & -\frac{1}{RC} \end{bmatrix}, B_2 = \begin{bmatrix} \frac{1}{L} & 0 \\ 0 & -\frac{1}{C} \end{bmatrix},$$

During DCM Period

$$A_3 = \begin{bmatrix} 0 & 0 \\ 0 & -\frac{1}{RC} \end{bmatrix}, B_3 = \begin{bmatrix} 0 & 0 \\ 0 & -\frac{1}{C} \end{bmatrix}.$$

According to (4), the model's expression would be:-

$$\frac{d}{dt} \begin{bmatrix} \bar{i}_L \\ \bar{v}_C \end{bmatrix} = \begin{bmatrix} 0 & -\frac{d_2}{L} \\ \frac{d_2}{C} & -\frac{1}{RC} \end{bmatrix} \begin{bmatrix} \bar{i}_L \\ \bar{v}_C \end{bmatrix} + \begin{bmatrix} \frac{d_1+d_2}{L} & 0 \\ 0 & -\frac{1}{C} \end{bmatrix} \begin{bmatrix} V_{in} \\ I_{load} \end{bmatrix}$$

We will introduce correction matrix as, where

$$K = \begin{bmatrix} \frac{1}{d_1+d_2} & 0 \\ 0 & 1 \end{bmatrix}.$$

From (8)

$$\frac{d}{dt} \begin{bmatrix} \bar{i}_L \\ \bar{v}_C \end{bmatrix} = \begin{bmatrix} 0 & -\frac{d_2}{L} \\ \frac{d_2}{C(d_1+d_2)} & -\frac{1}{RC} \end{bmatrix} \begin{bmatrix} \bar{i}_L \\ \bar{v}_C \end{bmatrix} + \begin{bmatrix} \frac{d_1+d_2}{L} & 0 \\ 0 & -\frac{1}{C} \end{bmatrix} \begin{bmatrix} V_{in} \\ I_{load} \end{bmatrix} \quad -(30)$$

By applying duty ratio constraint i.e.

$$d_2 = \frac{2L\bar{i}_L}{d_1 T_S v_{in}} - d_1$$

Into (30), we get

$$\frac{d\bar{i}_L}{dt} = \frac{2\bar{i}_L}{d_1 T_S v_{in}} (v_{in} - \bar{v}_C) + \frac{v_C d_1}{L} - (31)$$

And,

$$\frac{d\bar{v}_C}{dt} = \frac{2L\bar{i}_L - d_1^2 T_S v_{in}}{2LC\bar{i}_L} - \frac{v_C}{RC} - \frac{i_{load}}{C} - (32)$$

Now using linearization technique and applying perturbations to (31) and (32),

$$\begin{aligned} \bar{i}_L &= I_L + \tilde{i}_L; \\ \bar{v}_C &= V_C + \tilde{v}_C; \\ v_{in} &= V_{in} + \tilde{v}_{in}; \\ i_{load} &= I_{load} + \tilde{i}_{load}; \end{aligned}$$

We get small signal model as:-

$$\frac{d}{dt} \begin{bmatrix} \tilde{i}_L \\ \tilde{v}_C \end{bmatrix} = A \begin{bmatrix} \tilde{i}_L \\ \tilde{v}_C \end{bmatrix} + B \begin{bmatrix} \tilde{v}_{in} \\ \tilde{i}_{load} \end{bmatrix}$$

Where

$$A = \begin{bmatrix} \frac{2(V_{in}-V_C)}{d_1 T_s V_{in}} & \frac{-[2I_L L + d_1^2 T_s V_{in}]}{d_1 T_s V_{in} L} \\ \frac{R(1-I_{load})-V_C}{C} & \frac{-1}{RC} \end{bmatrix}, B = \begin{bmatrix} \frac{2I_L L + d_1^2 T_s V_C}{d_1 T_s V_{in} L} & 0 \\ \frac{-d_1^2 T_s}{2LCI_L} & \frac{-1}{C} \end{bmatrix}.$$

$$\text{Then, } \begin{bmatrix} \widetilde{v_L(s)} \\ \widetilde{v_C(s)} \end{bmatrix} = \tilde{X}(s) = (sI - A)^{-1} B U(s)$$

$$= \frac{1}{\Delta} \begin{bmatrix} s + \frac{1}{RC} & \frac{2I_L L + d_1^2 T_s V_{in}}{d_1 T_s V_{in} L} \\ \frac{V_C - R(1-I_{load})}{C} & s - \frac{2(V_{in}-V_C)}{d_1 T_s V_{in}} \end{bmatrix} \begin{bmatrix} \frac{2I_L L + d_1^2 T_s V_C}{d_1 T_s V_{in} L} & 0 \\ \frac{-d_1^2 T_s}{2LCI_L} & \frac{-1}{C} \end{bmatrix} \begin{bmatrix} \widetilde{v_{in}(s)} \\ \widetilde{v_{load}(s)} \end{bmatrix}$$

Where,

$$\Delta =$$

$$s^2 + s \left( \frac{1}{RC} - \frac{2(V_{in}-V_C)}{d_1 T_s V_{in}} \right) - \frac{2(V_{in}-V_C)}{d_1 T_s V_{in} RC} - \left( \frac{2I_L L + d_1^2 T_s V_{in}}{d_1 T_s V_{in} L} \right) \left( \frac{V_C - R(1-I_{load})}{C} \right)$$

$$\begin{bmatrix} \widetilde{v_L(s)} \\ \widetilde{v_C(s)} \end{bmatrix} =$$

$$\begin{bmatrix} \left( s + \frac{1}{RC} \right) \left[ \frac{2I_L L + d_1^2 T_s V_C}{d_1 T_s V_{in} L} \right] + \frac{(2I_L L + d_1^2 T_s V_{in}) [d_1^2 T_s]}{d_1 T_s V_{in} L \cdot 2LCI_L} & \frac{-[2I_L L + d_1^2 T_s V_{in}]}{d_1 T_s V_{in} LC} \\ \left[ s - \frac{2(V_{in}-V_C)}{d_1 T_s V_{in}} \right] \left( \frac{-d_1^2 T_s}{2LCI_L} \right) + \frac{(2I_L L + d_1^2 T_s V_C) [V_C - R(1-I_{load})]}{d_1 T_s V_{in} L \cdot C} & \left( s - \frac{2(V_{in}-V_C)}{d_1 T_s V_{in}} \right) \frac{-1}{C} \end{bmatrix} \cdot \begin{bmatrix} \widetilde{v_{in}(s)} \\ \widetilde{v_{load}(s)} \end{bmatrix} \cdot \frac{1}{\Delta}$$

Thus, Transfer functions can be formulated from small signal model to below equations

$$\frac{\widetilde{v_L(s)}}{\widetilde{v_{in}(s)}} = \left[ \left( s + \frac{1}{RC} \right) \left[ \frac{2I_L L + d_1^2 T_s V_C}{d_1 T_s V_{in} L} \right] + \frac{(2I_L L + d_1^2 T_s V_{in}) [d_1^2 T_s]}{d_1 T_s V_{in} L \cdot 2LCI_L} \right] \cdot \frac{1}{\Delta},$$

$$\frac{\widetilde{v_L(s)}}{\widetilde{v_{load}(s)}} = \left[ \frac{-[2I_L L + d_1^2 T_s V_{in}]}{d_1 T_s V_{in} LC} \right] \cdot \frac{1}{\Delta},$$

$$\frac{\widetilde{v_C(s)}}{\widetilde{v_{in}(s)}} = \left[ \left( s - \frac{2(V_{in} - V_C)}{d_1 T_s V_{in}} \right) \left( \frac{-d_1^2 T_s}{2LCI_L} \right) + \frac{(2I_L L + d_1^2 T_s V_C) [V_C - R(1 - I_{load})]}{d_1 T_s V_{in} L C} \right] \cdot \frac{1}{\Delta},$$

$$\frac{\widetilde{v_C(s)}}{\widetilde{v_{load}(s)}} = \left[ \left( s - \frac{2(V_{in} - V_C)}{d_1 T_s V_{in}} \right) \frac{1}{C} \right] \cdot \frac{1}{\Delta}$$

$$\frac{\widetilde{v_C(s)}}{\widetilde{v_{load}(s)}}$$

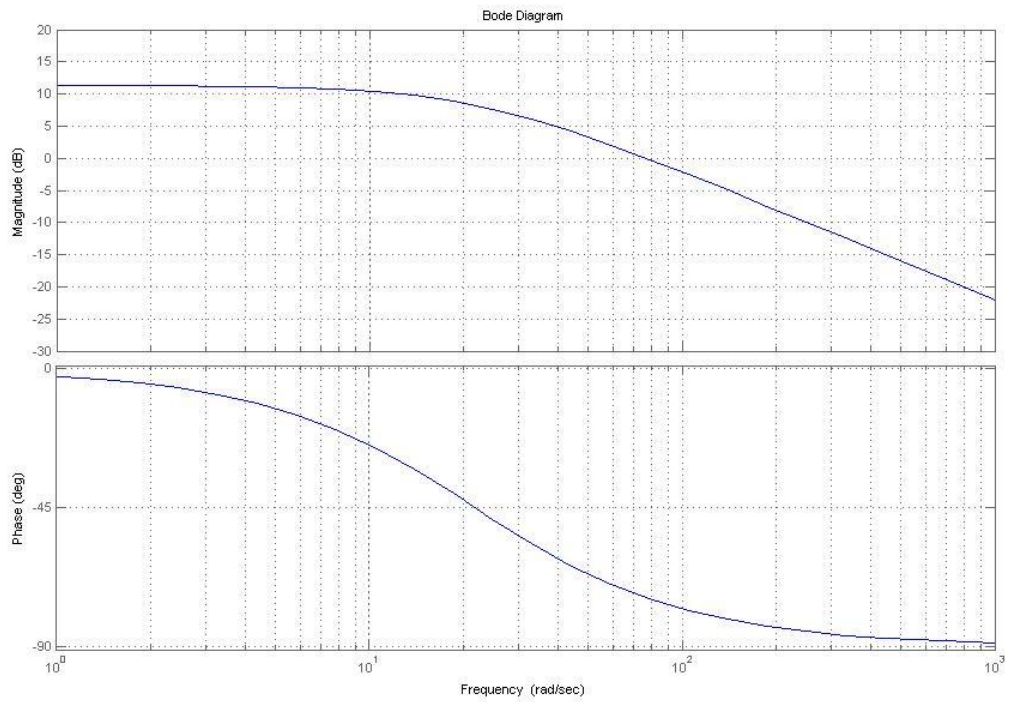

# Chapter 4

## **Inclusion of Parasitic In Model**

4.1 Overview

4.2 Transfer functions derivation considering parasitics

## 4.1 Overview:-

In the modelling of converter systems, due to the various difficulties faced in the complexities and modelling procedure, the parasitic such as switch conduction voltages, conduction resistances, diode drop and resistances, switching times and ESR's of capacitors are commonly ignored[8]. The idea of considering ideal/lossless components and leaving parasitic like we have derived model earlier, significantly simplifies model development and is of high importance as it contributes to the understanding of the main features of a switching system[9]. Most conventional modelling (like reduced order and Full Order Model) are adequate for this purpose. So it is no doubt that these modelling are successful in the primary stage design of a switching system. However the effects of parasitic and losses are important for improving model accuracy, study efficiency, dynamic performance, and robustness of system poles. The problem with including the parasitic leads to nonlinear current/voltage waveforms and further complicates the analytical derivations.

## 4.2 Parasitic Realization in DC-DC Converters:-

For a Boost Converter, circuit with parasitic will look like

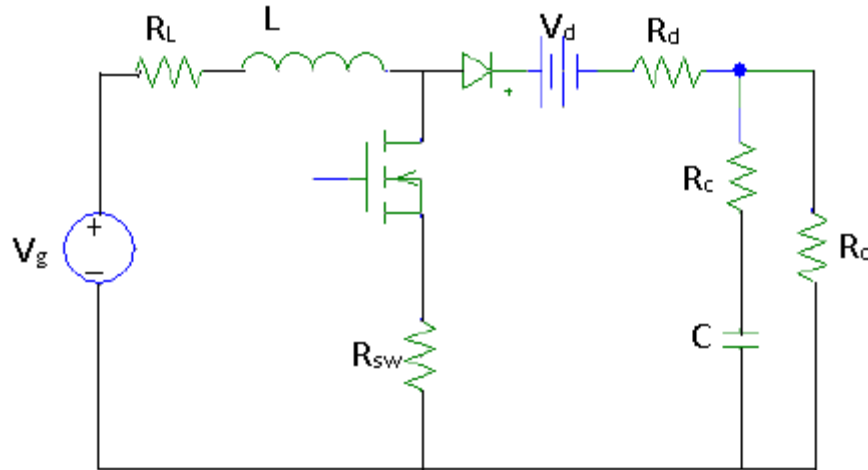

Fig 4.1

During ON State:

$$\frac{di_L}{dt} = \frac{[V_{in} - i_L(R_L + R_{sw})]}{L}$$

$$\frac{dv_C}{dt} = -\frac{V_C}{C(R_o + R_c)}$$

$$\Rightarrow \begin{bmatrix} \frac{di_L}{dt} \\ \frac{dv_C}{dt} \end{bmatrix} = \begin{bmatrix} \frac{(R_L + R_{sw})}{L} & 0 \\ 0 & \frac{-1}{C(R_o + R_c)} \end{bmatrix} \begin{bmatrix} i_L \\ v_C \end{bmatrix} + \begin{bmatrix} \frac{1}{L} \\ 0 \end{bmatrix} [v_{in}]$$

$$\text{Where, } A_1 = \begin{bmatrix} \frac{(R_L + R_{sw})}{L} & 0 \\ 0 & \frac{-1}{C(R_o + R_c)} \end{bmatrix} \text{ and } B_1 = \begin{bmatrix} \frac{1}{L} \\ 0 \end{bmatrix}$$



During OFF State:-

$$\frac{di_L}{dt} = \frac{[V_{in} - i_L(R_c + R_d) - V_d - V_o]}{L}$$

$$\frac{di_L}{dt} = \frac{\left[ V_{in} - i_L(R_c + R_d) - \frac{V_c}{\left(\frac{R_c}{R_o} + 1\right)} - \frac{i_L * R_c}{\left(\frac{R_c}{R_o} + 1\right)} \right]}{L} \quad (\because v_o = \frac{V_c + R_c * i_L}{\left(1 + \frac{R_c}{R_o}\right)})$$

$$\frac{dV_c}{dt} = \left( \frac{i_L - \frac{V_o}{R_o}}{C} \right)$$

$$= \left( i_L - \frac{V_c}{R_o \left(1 + \frac{R_c}{R_o}\right)} - \frac{R_c * i_L}{R_o \left(1 + \frac{R_c}{R_o}\right)} \right) / C$$

$$\begin{bmatrix} \frac{di_L}{dt} \\ \frac{dV_c}{dt} \end{bmatrix} = \begin{bmatrix} \frac{-(R_c + R_d)}{L} - \frac{R_c}{L \left(1 + \frac{R_c}{R_o}\right)} & \frac{-1}{\left(1 + \frac{R_c}{R_o}\right)} \\ \left[ 1 - \frac{R_c}{R_o \left(1 + \frac{R_c}{R_o}\right)} \right] / C & \frac{-1}{C R_o \left(1 + \frac{R_c}{R_o}\right)} \end{bmatrix} \begin{bmatrix} i_L \\ V_c \end{bmatrix} + \begin{bmatrix} \frac{1}{L} \\ 0 \end{bmatrix} [v_{in}]$$

$$\text{Where, } A_2 = \begin{bmatrix} \frac{-(R_c + R_d)}{L} - \frac{R_c}{L \left(1 + \frac{R_c}{R_o}\right)} & \frac{-1}{\left(1 + \frac{R_c}{R_o}\right)} \\ \left[ 1 - \frac{R_c}{R_o \left(1 + \frac{R_c}{R_o}\right)} \right] / C & \frac{-1}{C R_o \left(1 + \frac{R_c}{R_o}\right)} \end{bmatrix} \quad B_2 = \begin{bmatrix} \frac{1}{L} \\ 0 \end{bmatrix}$$

During DCM period:

$$\frac{di_L}{dt} = 0$$

$$\frac{dV_c}{dt} = - \frac{V_c}{C(R_o + R_c)}$$

$$\text{Thus, } \begin{bmatrix} \frac{di_L}{dt} \\ \frac{dv_C}{dt} \end{bmatrix} = \begin{bmatrix} 0 & 0 \\ 0 & \frac{-1}{C(R_o+R_c)} \end{bmatrix} \begin{bmatrix} i_L \\ v_C \end{bmatrix} + \begin{bmatrix} 0 \\ 0 \end{bmatrix} \begin{bmatrix} V_{in} \\ d \end{bmatrix}$$

$$\text{Where, } A_3 = \begin{bmatrix} 0 & 0 \\ 0 & \frac{-1}{C(R_o+R_c)} \end{bmatrix} \quad \text{and} \quad B_3 = \begin{bmatrix} 0 \\ 0 \end{bmatrix}$$

Now applying averaging technique, we get:-

$$A = A_1d_1 + A_2d_2 + A_3(1-d_1-d_2)$$

$$B = B_1d_1 + B_2d_2 + B_3(1-d_1-d_2)$$

Thus,

$$A = \begin{bmatrix} \frac{-d_1(R_l+R_{sw})}{L} - \frac{d_2}{L} \left\{ R_l + R_d \frac{R_c}{\left(1+\frac{R_c}{R_o}\right)} \right\} & \frac{-d_2}{\left(1+\frac{R_c}{R_o}\right)} \\ \frac{d_2}{C} \left[ \frac{R_o}{R_o+R_c} \right] & \frac{-1}{C(R_c+R_o)} \end{bmatrix}$$

And,

$$B = \begin{bmatrix} \frac{(d_1+d_2)}{L} \\ 0 \end{bmatrix}$$

Let correction Matrix be K and be defined as :-

$$K = \begin{bmatrix} \frac{1}{d_1+d_2} & 0 \\ 0 & 1 \end{bmatrix}$$

State space equation will look like:

$$\frac{d}{dt} \begin{bmatrix} \bar{i}_L \\ \bar{v}_C \end{bmatrix} = \begin{bmatrix} \frac{-d_1(R_l+R_{sw})}{L} - \frac{d_2}{L} \left\{ R_l + R_d \frac{R_c}{\left(1+\frac{R_c}{R_o}\right)} \right\} & \frac{-d_2}{\left(1+\frac{R_c}{R_o}\right)} \\ \frac{d_2}{C} \left[ \frac{R_o}{R_o+R_c} \right] & \frac{-1}{C(R_c+R_o)} \end{bmatrix} \begin{bmatrix} \frac{1}{d_1+d_2} & 0 \\ 0 & 1 \end{bmatrix} \begin{bmatrix} \bar{i}_L \\ \bar{v}_C \end{bmatrix}$$

$$+ \begin{bmatrix} \frac{(d_1+d_2)}{L} \\ 0 \end{bmatrix} [v_{in}]$$

By using duty constraint  $d_2$ , i.e.

$$d_2 = \frac{2L\bar{t}_L}{d_1 T_S v_{in}} - d_1$$

In the above state space equation, replace  $d_2$  by duty constraint, we get

$$\begin{aligned} \frac{d\bar{t}_L}{dt} = & \frac{-d_1}{\left(\frac{2L^2\bar{t}_L}{d_1 T_S v_{in}}\right)} (R_L + R_{SW})\bar{t}_L \\ & - \frac{\left[\frac{2L\bar{t}_L}{d_1 T_S v_{in}} - d_1\right]}{\left(\frac{2L^2\bar{t}_L}{d_1 T_S v_{in}}\right)} \left[R_L + R_D + \frac{R_C R_O}{R_C + R_O}\right] \bar{t}_L \\ & - \left(\frac{2L\bar{t}_L}{d_1 T_S v_{in}} - d_1\right) \frac{R_O \bar{v}_C}{R_C + R_O} + \frac{2\bar{t}_L}{d_1 T_S} - \left(\frac{2L\bar{t}_L}{d_1 T_S v_{in}} - d_1\right) \frac{v_{in}}{L} \end{aligned}$$

And,

$$\frac{d\bar{v}_C}{dt} = \frac{\left(\frac{2L\bar{t}_L}{d_1 T_S v_{in}} - d_1\right)}{\frac{2L\bar{t}_L}{d_1 T_S v_{in}}} \frac{R_O}{C(R_O + R_C)} \bar{t}_L - \frac{\bar{v}_C}{C(R_O + R_C)}$$

Now, apply perturbations we can get small signal model as:-

$$\frac{d}{dt} \begin{bmatrix} \tilde{t}_L \\ \tilde{v}_C \end{bmatrix} = A \begin{bmatrix} \tilde{t}_L \\ \tilde{v}_C \end{bmatrix} + B \begin{bmatrix} \tilde{v}_{in} \\ \tilde{d} \end{bmatrix}$$

Where

$$A = \begin{bmatrix} \frac{A_1}{DV_{in}} & \frac{A_2}{DV_{in}} \\ \frac{R_O}{C(R_O+R_C)} & -1 \end{bmatrix}, B = \begin{bmatrix} \frac{A_3}{DV_{in}} & \frac{A_4}{DV_{in}} \\ \frac{-D^2 T_S R_O}{2LC(R_O+R_C)} & \frac{-D T_S v_{in} R_O}{LC(R_O+R_C)} \end{bmatrix}$$

$$A_1 = \frac{v_{in} D}{L} \left( R_L + R_d + \frac{R_C R_O}{R_C + R_O} \right) - \frac{2L v_C}{T_S} \left( \frac{R_O}{R_O + R_C} \right) + \frac{2v_{in}}{T_S};$$

$$A_2 = -\frac{2LV_C}{T_S} \left( \frac{R_O}{R_O + R_C} \right) I_L + D^2 V_{in} \frac{R_O}{R_O + R_C};$$

$$A_3 = \frac{D^3 T_S V_{in}}{L^2} \left( R_d - R_{SW} + \frac{R_C R_O}{R_C + R_O} \right) + D^2 V_C \frac{R_O}{R_O + R_C} + \frac{2I_L}{T_S} \\ - \frac{I_L D}{L} \left( R_d + R_C + \frac{R_C R_O}{R_C + R_O} \right)$$

$$A_4 = \frac{3D^2 T_S V_{in}^2}{2L^2} \left( R_d - R_{SW} + \frac{R_C R_O}{R_C + R_O} \right) - \frac{I_L D}{L} \left( R_d + R_C + \frac{R_C R_O}{R_C + R_O} \right)$$

Then,  $\begin{bmatrix} \widetilde{l_L(s)} \\ \widetilde{v_C(s)} \end{bmatrix} = \tilde{X}(s) = (sI - A)^{-1} B U(s)$

$$(sI - A)^{-1} = \left\{ \begin{bmatrix} s & 0 \\ 0 & s \end{bmatrix} - \begin{bmatrix} \frac{A_1}{DV_{in}} & \frac{A_2}{DV_{in}} \\ \frac{R_O}{C(R_O+R_C)} & -1 \end{bmatrix} \right\}^{-1} \\ = \frac{1}{\Delta} \begin{bmatrix} s + \frac{1}{C(R_O+R_C)} & -\frac{A_2}{DV_{in}} \\ -\frac{R_O}{C(R_O+R_C)} & s - \frac{A_1}{DV_{in}} \end{bmatrix}$$

Where,  $\Delta = s^2 + s \left( \frac{1}{C(R_O+R_C)} - \frac{A_1}{DV_{in}} \right) - \frac{1}{C(R_O+R_C)} \frac{A_1}{DV_{in}} + \frac{A_2}{DV_{in}} \frac{R_O}{C(R_O+R_C)}$

$$\begin{bmatrix} \widetilde{l_L(s)} \\ \widetilde{v_C(s)} \end{bmatrix} = \frac{1}{\Delta} \begin{bmatrix} s + \frac{1}{C(R_O+R_C)} & -\frac{A_2}{DV_{in}} \\ -\frac{R_O}{C(R_O+R_C)} & s - \frac{A_1}{DV_{in}} \end{bmatrix} * \begin{bmatrix} \frac{A_3}{DV_{in}} & \frac{A_4}{DV_{in}} \\ \frac{-D^2 T_S R_O}{2LC(R_O+R_C)} & \frac{-DT_S V_{in} R_O}{LC(R_O+R_C)} \end{bmatrix} * \begin{bmatrix} \widetilde{v_{in}(s)} \\ \widetilde{d(s)} \end{bmatrix}$$

$$\begin{bmatrix} \widetilde{i_L(s)} \\ \widetilde{v_C(s)} \end{bmatrix} = \begin{bmatrix} s + \frac{1}{C(R_O+R_C)} \left( \frac{A_3}{DV_{in}} \right) + \frac{D^2 T_S R_O A_2}{2LCDV_{in}(R_O+R_C)} & \frac{sA_4}{DV_{in}} + \frac{A_4}{CDV_{in}(R_O+R_C)} + \frac{-DT_S A_2 V_{in} R_O}{LCDV_{in}(R_O+R_C)} \\ \frac{-R_O A_3}{DV_{in} C(R_O+R_C)} - \frac{sD^2 T_S R_O}{2LC(R_O+R_C)} + \frac{A_1 DT_S R_O}{2LCV_{in}(R_O+R_C)} & \frac{-DT_S V_{in} R_O}{LC(R_O+R_C)} - \frac{sDT_S V_{in} R_O}{LC(R_O+R_C)} - \frac{R_O A_4}{CDV_{in}(R_O+R_C)} \end{bmatrix} * \begin{bmatrix} \widetilde{v_{in}(s)} \\ \widetilde{d(s)} \end{bmatrix} \cdot \frac{1}{\Delta}$$

Thus, Transfer functions can be formulated from small signal model to below equations

$$\frac{\widetilde{i_L(s)}}{\widetilde{v_{in}(s)}} = \left[ s + \frac{1}{C(R_O+R_C)} \left( \frac{A_3}{DV_{in}} \right) + \frac{D^2 T_S R_O A_2}{2LCDV_{in}(R_O+R_C)} \right] \cdot \frac{1}{\Delta},$$

$$\frac{\widetilde{i_L(s)}}{\widetilde{d(s)}} = \left[ \frac{sA_4}{DV_{in}} + \frac{A_4}{CDV_{in}(R_O+R_C)} + \frac{-DT_S A_2 V_{in} R_O}{LCDV_{in}(R_O+R_C)} \right] \cdot \frac{1}{\Delta},$$

$$\frac{\widetilde{v_C(s)}}{\widetilde{v_{in}(s)}} = \left[ \frac{-R_O A_3}{DV_{in} C(R_O+R_C)} - \frac{sD^2 T_S R_O}{2LC(R_O+R_C)} + \frac{A_1 DT_S R_O}{2LCV_{in}(R_O+R_C)} \right] \cdot \frac{1}{\Delta},$$

$$\frac{\widetilde{v_C(s)}}{\widetilde{d(s)}} = \left[ \frac{-DT_S V_{in} R_O}{LC(R_O+R_C)} - \frac{sDT_S V_{in} R_O}{LC(R_O+R_C)} - \frac{R_O A_4}{CDV_{in}(R_O+R_C)} \right] \cdot \frac{1}{\Delta}$$

$$v_o = \frac{v_C + R_C i_L}{1 + R_C/R_O} = \frac{v_C}{1 + R_C/R_O} + \frac{R_C i_L}{1 + R_C/R_O}$$

$$v_o = \begin{bmatrix} \frac{R_C}{1 + R_C/R_O} & \frac{1}{1 + R_C/R_O} \end{bmatrix} \begin{bmatrix} i_L \\ v_C \end{bmatrix}$$

This is in the form of:-

$$Y(s) = C(s) X(s)$$

We know that,

$$X(s) = (sI - A)^{-1} B(s) U(s)$$

Thus,

$$Y(s) = C(s) (sI - A)^{-1} B(s) U(s)$$

$$Y(s) = \left[ \begin{array}{cc} \frac{R_C}{1 + R_C/R_O} & \frac{1}{1 + R_C/R_O} \end{array} \right] * \left[ \begin{array}{c} s + \frac{1}{C(R_O + R_C)} \left( \frac{A_3}{DV_{in}} \right) + \frac{D^2 T_S R_O A_2}{2LC DV_{in}(R_O + R_C)} \quad \frac{sA_4}{DV_{in}} + \frac{A_4}{CDV_{in}(R_O + R_C)} + \frac{-DT_S A_2 V_{in} R_O}{LCDV_{in}(R_O + R_C)} \\ \frac{-R_O A_3}{DV_{in} C(R_O + R_C)} - \frac{sD^2 T_S R_O}{2LC(R_O + R_C)} + \frac{A_1 DT_S R_O}{2LCV_{in}(R_O + R_C)} \quad \frac{-DT_S V_{in} R_O}{LC(R_O + R_C)} - \frac{sDT_S V_{in} R_O}{LC(R_O + R_C)} - \frac{R_O A_4}{CDV_{in}(R_O + R_C)} \end{array} \right] * \left[ \begin{array}{c} \widetilde{v_{in}(s)} \\ \widetilde{d(s)} \end{array} \right] \frac{1}{\Delta}$$

$$v_o(s) = \frac{1}{\Delta} \left[ \begin{array}{cc} R_C & 1 \\ 1 + R_C/R_O & 1 + R_C/R_O \end{array} \right] \begin{bmatrix} M_1 & M_2 \\ M_3 & M_4 \end{bmatrix} \begin{bmatrix} \widetilde{v_{in}(s)} \\ \widetilde{d(s)} \end{bmatrix}$$

Thus, two transfer functions are:-

$$\frac{\widetilde{v_o(s)}}{\widetilde{v_{in}(s)}} = \frac{1}{\Delta} \frac{1}{1 + R_C/R_O} \{M_1 R_C + M_3\}$$

$$\frac{\widetilde{v_o(s)}}{\widetilde{d(s)}} = \frac{1}{\Delta} \frac{1}{1 + R_C/R_O} \{M_2 R_C + M_4\}$$

Taking :

$L=5\mu\text{H}$ ,  $C=40\mu\text{F}$ ,  $f_s=100\text{kHz}$  ( $T_s=10\mu\text{s}$ ),  $V_g=5\text{V}$ ,  $R=20\Omega$ ,  $D=0.7$   $R_C=30\text{m}\Omega$

$R_d=.15\Omega$ ,  $R_L=.176\Omega$ ,  $R_{sw}=.17\Omega$

## Bode plot of $\frac{v_o(s)}{d(s)}$

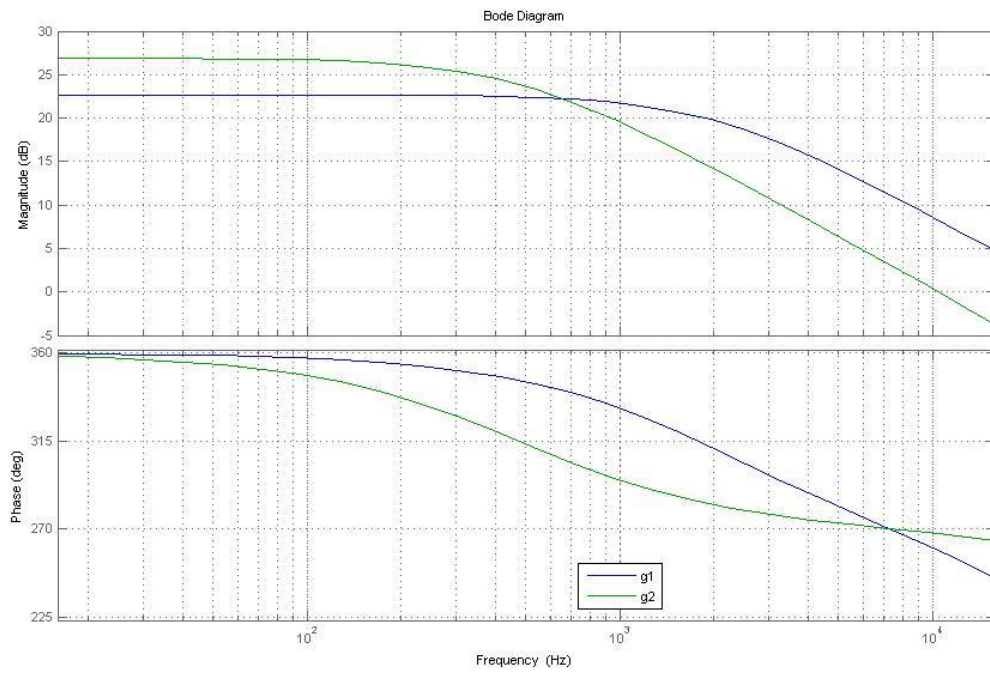

g1= With parasitic  
g2= Without parasitic

**Bode plot of  $\frac{\overline{v_o(s)}}{\overline{v_{in}(s)}}$**

g1=Without parasitic.

g2=With parasitic.

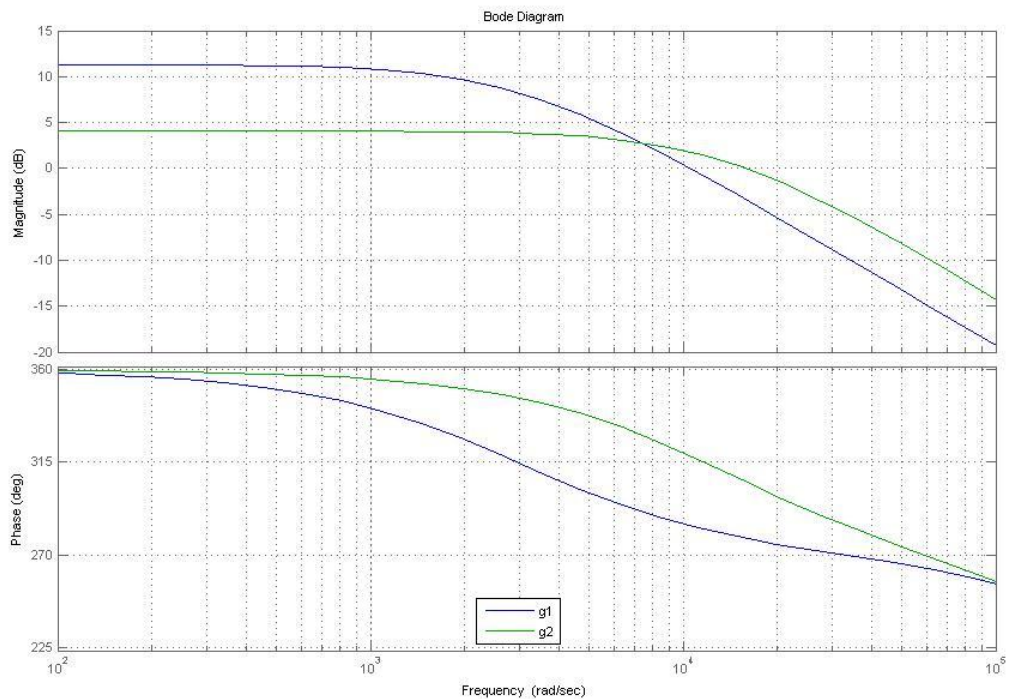

**Conclusion for Bode plot:**-From the bode plot we can derive the inference that in the low frequency range the gain magnitude decreases by 5 dB as we take into account the effect of parasitic in the model.





# Chapter 5

## Conclusion

**F**irstly we have studied the various aspects of averaged modelling of DC-DC converter(buck and boost) operating in discontinuous conduction mode. The modelling procedure consists of basic three steps:

- Averaging the matrix parameters and selection of the correction matrix (K) depending on the number of inductor currents of the converter.
- Representation of state space equations into the differential equations of inductor current and capacitor voltage.
- Defining an duty ratio constraint so that the expression consists of only one duty ratio.

We have plotted various bode diagrams for reduced averaged model and new full order model and found out that, reduced order can estimate the behavior in low frequency range but in new order model, since dynamics of inductor is present, it is more precise.

We have also modeled the load into a constant current source and parallel resistance so as to obtain the output impedance transfer function which can be utilized for designing of Controller.



After that, various components parasitic are taken into consideration and a full order model is developed. On comparing IDEAL and NON-IDEAL model behavior through bode plot of control transfer function, we have found that the model verifies the fact that dc gain decreases in case of parasitic.

## REFERENCES:-

- [1] J. Sun, Daniel M. Mitchell, Matthew F. Greuel, Philip T. Krein and Richard M. Bass, "Averaged Modelling of PWM Converters Operating in Discontinuous Mode," *IEEE Transaction on Power Electronics*, Volume 16, NO. 4, Jul 2001.
- [2] Robert W. Erickson and Dragon Maksimovic, *Fundamentals of Power Electronics*, Second Edition, Springer International Edition, Chapter-5.
- [3] S. Cuk and R. D. Middle brook, "A General Unified Approach to modeling switching DC-to-DC converters in Discontinuous Conduction Mode(DCM)," in *Proc. IEEE PESC'77*, pp. 36–57, 1977.
- [4] R. Tymerski and V. Vorperian, "Generation, Classification and Analysis of Switched-mode DC-to-DC converters by the use of Converter cells," in *Proc. INTELEC'86*, pp. 181–195, Oct. 1986.
- [5] D. Maksimovic and S. Cuk, "A Unified Analysis of PWM converters in Discontinuous mode," *IEEE Transaction On Power Electronics*, Volume 6, pp. 476–490, May 1991.
- [6] V. Vorperian, "Simplified analysis of PWM converters using model of PWM switch, Part II: Discontinuous conduction mode," *IEEE Transaction on Aerospace Electron. Systems*, Volume 26, pp. 497–505, May 1990.
- [7] Xin Cheng and Guang-jun Xie, "Full Order Models and Simulation of Boost Converters Operating in DCM," 2009 International Conference on Electronic Computer Technology.
- [8] Chun T. Rim, Gyu B. Joung, and Gyu H. Cho, "Practical Switch Based State-Space Modeling of DC-DC Converters with All Parasitics," *IEEE Trans. on power electronics*, vol. 6 No. 4 October 1991
- [9] Ali Davoudi and Juri Jatskevich, "Parasitics Realization in State-Space Average-Value Modeling of PWM DC–DC Converters Using an Equal Area Method," *IEEE Tran. On circuits and systems-I: regular papers*, vol. 54, No. 9, September.