

12

Fundamentals of Alternating Current

In this chapter, we lead you through a study of the mathematics and physics of alternating current (AC) circuits. After completing this chapter you should be able to:

- ❑ Develop a familiarity with sinusoidal functions.
- ❑ Write the general equation for a sinusoidal signal based on its amplitude, frequency, and phase shift.
- ❑ Define angles in degrees and radians.
- ❑ Manipulate the general equation of a sinusoidal signal to determine its amplitude, frequency, phase shift at any time.
- ❑ Compute peak, RMS, and average values of voltage and current.
- ❑ Define root-mean-squared amplitude, angular velocity, and phase angle.
- ❑ Convert between time domain and phasor notation.
- ❑ Convert between polar and rectangular form.
- ❑ Add, subtract, multiply, and divide phasors.
- ❑ Discuss the phase relationship of voltage and current in resistive, inductive, and capacitive loads.
- ❑ Apply circuit analysis using phasors.
- ❑ Define components of power and realize power factor in AC circuits.
- ❑ Understand types of connection in three-phase circuits.

FOCUS ON MATHEMATICS

This chapter relates the application of mathematics to AC circuits, covering complex numbers, vectors, and phasors. All these three concepts follow the same rules.

REFERENCES

- Stephan J. Chapman, *Electric Machinery Fundamentals*, Third Edition, McGraw-Hill, 1999.
- Stephan J. Chapman, *Electric Machinery and Power System Fundamentals*, McGraw-Hill, 2002.
- Bosels, *Electrical Systems Design*, Prentice Hall.
- James H. Harter and Wallace D. Beitzel, *Mathematics Applied to Electronics*, Prentice Hall.

12.1 INTRODUCTION

The majority of electrical power in the world is generated, distributed, and consumed in the form of 50- or 60-Hz sinusoidal alternating current (AC) and voltage. It is used for household and industrial applications such as television sets, computers, microwave ovens, electric stoves, to the large motors used in the industry.

AC has several advantages over DC. The major advantage of AC is the fact that it can be transformed, however, direct current (DC) cannot. A transformer permits voltage to be stepped up or down for the purpose of transmission. Transmission of high voltage (in terms of kV) is that less current is required to produce the same amount of power. Less current permits smaller wires to be used for transmission.

In this chapter, we will introduce a sinusoidal signal and its basic mathematical equation. We will discuss and analyze circuits where currents $i(t)$ and voltages $v(t)$ vary with time. The phasor analysis techniques will be used to analyze electric circuits under sinusoidal steady-state operating conditions. Single-phase power will conclude the chapter.

12.2 SINUSOIDAL WAVEFORMS

AC unlike DC flows first in one direction then in the opposite direction. The most common AC waveform is a sine (or sinusoidal) waveform. Sine waves are the signal whose shape neither is nor altered by a linear circuit, therefore, it is ideal as a test signal.

In discussing AC signal, it is necessary to express the current and voltage in terms of maximum or peak values, peak-to-peak values, effective values, average values, or instantaneous values. Each of these values has a different meaning and is used to describe a different amount of current or voltage. Figure 12-1 is a plot of a sinusoidal wave. The correspondence mathematical form is

	$v(t) = V_p \cos(\omega t + \theta)$	(12.1)
--	--------------------------------------	--------

Where V_p is the peak voltage, $\omega = 2\pi f$ is the angular speed expressed in radians per second (rad/s), f is the frequency expressed in Hertz (Hz), t is the time expressed in second (s), and θ is phase of the sinusoid expressed in degrees.

The function (Figure 12-1) starts at a value of 0 at 0° , and rise smoothly to a maximum of 1 at 90° . They then fall, just as they rose, back to 0° at 180° . The negative peak is reached three quarters of the way at 270° . The function then returns symmetrically to 0° at 360° .

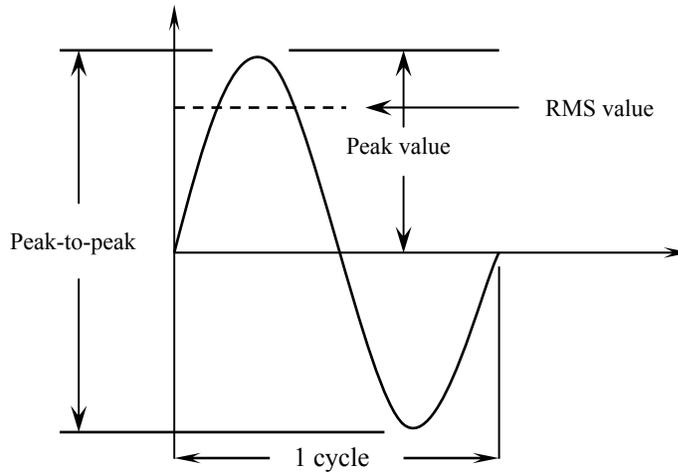

Figure 12-1 Sinusoidal wave values.

12.2.1 Radian and Degree

A degree is a unit of measurement in degree (its designation is ° or deg), a turn of a ray by the 1/360 part of the one complete revolution. So, the complete revolution of a ray is equal to 360 deg.

A radian is defined as the central angle, for which lengths of its arc and radius are equal ($AB = AO$). An arc length is the distance along the arc of a circle from the origin to the end of the angle. These terms are shown in Figure 13-8.

Following Equation (12.1), a length of a circumference C and its radius r can be expressed as:

	$2\pi = \frac{C}{R}$	(12.2)
--	----------------------	--------

So, a round angle, equal to 360° in a degree measure, is simultaneously 2π in a radian measure. Hence, we receive a value of one radian:

	$1 \text{ rad} = \frac{360}{2\pi} \approx 57.3^\circ$	(12.3)
--	---	--------

and,

	$1 \text{ deg} = \frac{2\pi}{360} \approx 0.017453 \text{ rad}$	(12.4)
--	---	--------

The following comparative table of degree and radian provides measure for some angles we often deal with:

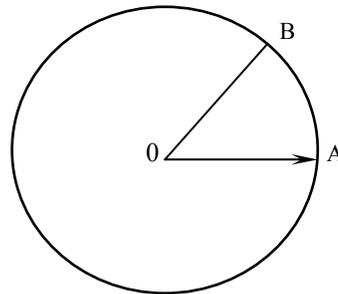

Figure 12-2 Radian and arc length.

Table 12-1 Angles in Degree and Radian

Angle (deg)	0	45	90	180	270	360
Angle (rad)	0	$\pi/4$	$\pi/2$	π	$3\pi/2$	2π

12.2.2 Peak and Peak-to-Peak Values

During each complete cycle of AC signal there are always two maximum or peak values, one for the positive half-cycle and the other for the negative half-cycle.

The peak value is measured from zero to the maximum value obtained in either the positive or negative direction.

The difference between the peak positive value and the peak negative value is called the peak-to-peak value of the sine wave. This value is twice the maximum or peak value of the sine wave and is sometimes used for measurement of ac voltages. The peak value is one-half of the peak-to-peak value.

12.2.3 Instantaneous Value

The instantaneous value of an AC signal is the value of voltage or current at one particular instant. The value may be zero if the particular instant is the time in the cycle at which the polarity of the voltage is changing. It may also be the same as the peak value, if the selected instant is the time in the cycle at which the voltage or current stops increasing and starts decreasing. There are actually an infinite number of instantaneous values between zero and the peak value.

12.2.4 Average Value

The average value of an AC current or voltage is the average of all the instantaneous values during one alternation. They are actually DC values. The average value is the amount of voltage that would be indicated by a DC voltmeter if it were connected across the load resistor.

Since the voltage increases from zero to peak value and decreases back to zero during one alternation, the average value must be some value between those two limits. It is possible to determine the average value by adding together a series of instantaneous values of the alternation (between 0° and 180°), and then dividing the sum by the number of instantaneous values used. The computation would show that one alternation of a sine wave has an average value equal to 0.636 times the peak value. The formula for a average voltage is

	$V_{av} = 0.636V_{max}$	(12.5)
--	-------------------------	----------

Where V_{av} is the average voltage for one alteration, and V_{max} is the maximum or peak voltage. Similarly, the formula for average current is

	$I_{av} = 0.636I_{max}$	(12.6)
--	-------------------------	----------

Where I_{av} is the average current for one alteration, and I_{max} is the maximum or peak current.

12.2.5 Effective Value

This is the value of AC signal that will have the same effect on a resistance as a comparable value of direct voltage or current will have on the same resistance. It is possible to compute the effective value of a sine wave of current to a good degree of accuracy by taking equally spaced instantaneous values of current along the curve and extracting the square root of the average of the sum of the squared values. For this reason, the effective value is often called the “root-mean-square” (RMS) value. Therefore,

	$I_{eff} = \sqrt{\text{Average of the sum of the squares of } I_{ins}}$	(12.7)
--	---	----------

The effective or rms value (I_{eff}) of a sine wave of current is 0.707 times the maximum value of current (I_{max}). Thus, $I_{eff} = 0.707 \times I_{max}$. When I_{eff} is known, we may find I_{max} by using the formula $I_{max} = 1.414 \times I_{eff}$. We might wonder where the constant 1.414 comes from. To find out, examine Figure and read the following explanation. Assume that the DC in Figure is maintained at 1 A and the resistor

temperature at 100°C. Also assume that the AC in Figure is increased until the temperature of the resistor is 100° C. At this point it is found that a maximum AC value of 1.414 A is required in order to have the same heating effect as DC. Therefore, in the AC circuit the maximum current required is 1.414 times the effective current.

When a sinusoidal voltage is applied to a resistance, the resulting current is also a sinusoidal. This follows Ohm's law which states that current is directly proportional to the applied voltage. Ohm's law, Kirchhoff's law, and the various rules that apply to voltage, current, and power in a DC circuit also apply to the AC circuit. Ohm's law formula for an AC circuit may be stated as

	$I_{eff} = \frac{V_{eff}}{R}$	(12.8)
--	-------------------------------	--------

Importantly, all AC voltage and current values are given as effective values.

12.2.6 Frequency

If the signal in the Figure makes one complete revolution each second, the generator produces one complete cycle of AC during each second (1 Hz). Increasing the number of revolutions to two per second will produce two complete cycles of ac per second (2 Hz). The number of complete cycles of alternating current or voltage completed each second is referred to as the "frequency, f " or "event frequency". Event frequency is always measured and expressed in hertz. Because there are 2π radians in a full circle, a cycle, the relationship between ω , f , and period, T , can be expressed as

	$\omega = 2\pi f = \frac{2\pi}{T} \text{ radians/second}$	(12.9)
--	---	--------

Where ω is the angular velocity in radians per second (rad/s). The dimension of frequency is reciprocal second. The frequency is an important term to understand since most AC electrical equipment requires a specific frequency for proper operation.

Example 12-1

Express each of the following frequencies in Hertz

- a) 40 cycles in 4.0 seconds
- b) 80 cycles in 200 milliseconds
- c) 1000 revolutions in 0.5 seconds
- d) 600 rotations in 1 minute

Solution:

- a) $40/4.0 = 10$ cycles per second = 10 Hz
- b) $80/0.2 = 400$ cycles per second = 400 Hz
- c) $1000/0.5 = 2000$ cycles per second = 4000 Hz (4 kHz)
- d) $600/60 = 10$ cycles per second = 10 Hz

Example 12-2

Express each of the following as angular velocity in radians per second

- a) 80 rad in 10 s
- b) 2.5 krad in 50 s
- c) 400 rad in 200 s
- d) 40 Mrad in 10 s

Solution:

- a) $\omega = 80/10 = 8$ rad/s
- b) $\omega = 2500/50 = 500$ rad/s
- c) $\omega = 400/200 = 2.0$ rad/s
- d) $\omega = (40 \times 10^6)/10 = 4.0$ rad/s

Example 12-3

Express each of the following frequencies as angular velocity in radians per second

- a) 60 Hz
- b) 500 Hz
- c) 10 kHz
- d) 1 MHz

Solution:

- a) $\omega = 2\pi \times 60 = 377 \text{ rad/s}$
- b) $\omega = 2\pi \times 500 = 3141.5 \text{ rad/s}$
- c) $\omega = 2\pi \times (10 \times 10^3) = 62.83 \text{ krad/s}$
- d) $\omega = 2\pi \times (1.0 \times 10^6) = 6.28 \text{ Mrad/s}$

12.2.7 Period

The period of a waveform is the time required for completing one full cycle. It is measured in seconds. In Figure 15-1, the sinusoidal waveform is plotted as a function of the argument ωt , and the periodic nature of the sine wave is evident. The function repeats itself every 2π radians, and its period is therefore 2π radians. The relationship between time (T) and frequency (f) is indicated by the formulas

	$T = \frac{1}{f}$	(12.10)
--	-------------------	---------

Example 12-4

Express each of the following periods in seconds

- a) 500 Hz
- b) 90 kHz
- c) 900 MHz
- d) 5 Hz

Solution: Use Equation (12.10)

- a) $T = 2 \text{ ms}$
- b) $T = 1/(90 \times 10^3) = 11.11 \text{ } \mu\text{s}$
- c) $T = 1/(900 \times 10^6) = 1.11 \text{ ps}$
- d) $T = 0.2 \text{ s}$

12.2.8 Phase

When two sinusoidal waves, such as those represented by Figure 12-3, are precisely in step with one another, they are said to be in phase. To be in phase,

the two waves must go through their maximum and minimum points at the same time and in the same direction.

To further describe the phase relationship between two sinusoidal waves, the terms lead and lag are used. The amount by which one sine wave leads or lags another sine wave is measured in degrees. According to Figure 12-3, the sinusoid $V_p \sin(\omega t + \theta)$ occur θ rad, θ degrees seconds, earlier. In this case we say $V_p \sin(\omega t + \theta)$ leads $V_p \sin \omega t$ by θ . Also, we may say that $V_p \sin \omega t$ lags $V_p \sin(\omega t + \theta)$ by θ .

In general, it is possible for one sine wave to lead or lag another sine wave by any number of degrees, except 0° or 360° . When the latter condition exists, the two waves are said to be in phase. Thus, two sine waves that differ in phase by 45° , for example, are actually out of phase with each other, whereas two sine waves that differ in phase by 360° are considered to be in phase with each other.

To determine the phase difference between two sine waves, locate the points on the time axis where the two waves cross the time axis traveling in the same direction. The number of degrees between the crossing points is the phase difference. The wave that crosses the axis at the later time (to the right on the time axis) is said to lag the other wave.

12.2.9 Sine and Cosine

The sine and cosine are essentially the same function, but with a 90° phase difference. For example, $\sin \omega t = \cos(\omega t - 90^\circ)$. Multiples of 360° may be added to or subtracted from the argument of any sinusoidal function without changing the value of the function. To realize this, let us consider

	$ \begin{aligned} v_1 &= V_{p1} \cos(10t + 20^\circ) \\ &= V_{p1} \sin(10t + 90^\circ + 20^\circ) \\ &= V_{p1} \sin(10t + 110^\circ) \end{aligned} $	(12.11)
--	--	---------

leads

	$v_2 = V_{p2} \sin(10t - 40^\circ)$	(12.12)
--	-------------------------------------	---------

by 150° . It is also correct to say that v_1 lags v_2 by 210° , since v_1 may be written as

	$v_1 = V_{p1} \sin(10t - 250^\circ)$	(12.13)
--	--------------------------------------	---------

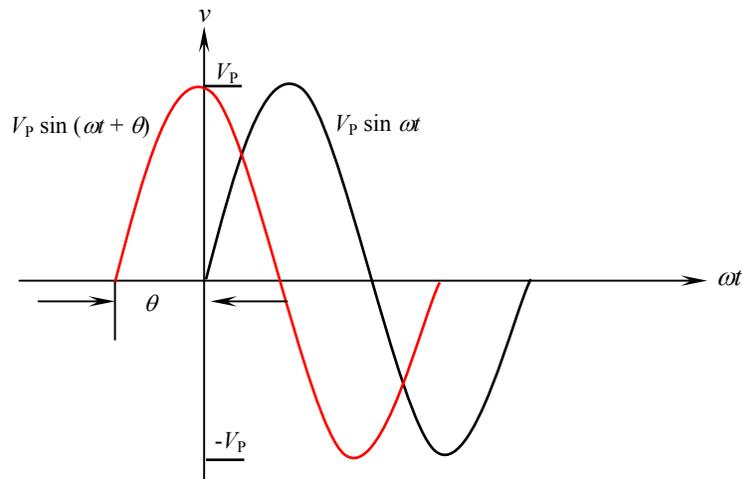

Figure 12-3 The sine wave $V_p \sin(\omega t + \theta)$ leads $V_p \sin \omega t$.

12.3 PHASORS

We have learnt from the previous section how to define and express in a single equation the magnitude, frequency, and phase shift of a sinusoidal signal. Any linear circuit that contains resistors, capacitors, and inductors do not alter the shape of this signal, nor its frequency. However, the linear circuit does change the amplitude of the signal (amplification or attenuation) and shift its phase (causing the output signal to lead or lag the input). The amplitude and phase are the two important quantities that determine the way the circuit affects the signal. Accordingly, signal can be expressed as a linear combination of complex sinusoids. Phase and magnitude defines a phasor (vector) or complex number. The phasor is similar to vector that has been studied in mathematics.

Figure 12-4 shows how AC sinusoidal quantities are represented by the position of a rotating vector. As the vector rotates it generates an angle. The location of the vector on the plane surface is determined by the magnitude (length) of the vector and by the generated angle.

Representing sinusoidal signals by phasors is useful since circuit analysis laws such as KVL and KCL and familiar algebraic circuit analysis tools, such as series and parallel equivalence, voltage and current division are applicable in the phasor domain, which have been studied in DC circuits can be applied. We do not need new analysis techniques to handle circuits in the phasor domain. The only difference is that circuit responses are phasors (complex numbers) rather than DC signals (real numbers).

In order to work with these complex numbers without drawing vectors, we first need some kind of standard mathematical notation. There are two basic forms of complex number notation: polar and rectangular.

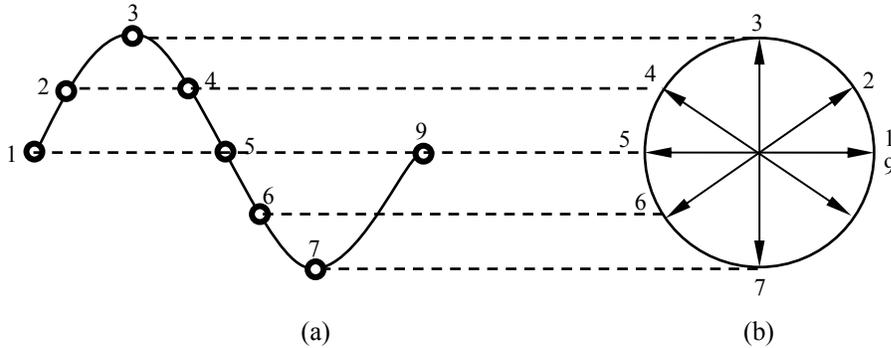

Figure 12-4 (a) Magnitude of a sine wave. (b) A vector with its end fixed at the origin and rotating in a counterclockwise (CCW) direction representing the varying conditions of the AC signal.

12.3.1 Polar Form

Polar form is where the length (magnitude) and the angle of its vector denote a complex number. Standard orientation for vector angles in AC circuit calculations defines 0° as being to the right (horizontal), making 90° straight up, 180° to the left, and 270° straight down. Vectors angled “down” can have angles represented in polar form as positive numbers in excess of 180 or negative numbers less than 180 (Figure 12-5). For example, a vector angled $\angle 270^\circ$ (straight down) can also be said to have an angle of -90° .

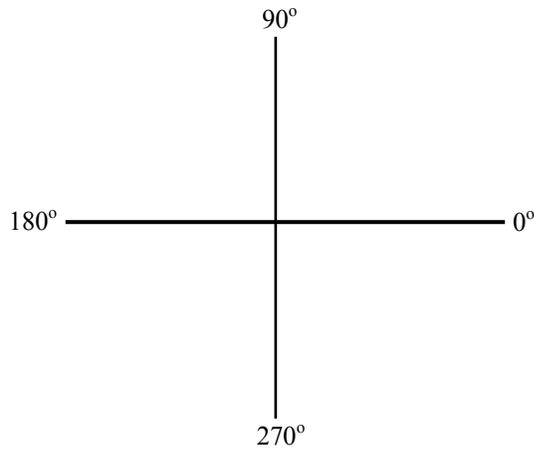

Figure 12-5 Standard orientation for vector angles.



Figure 12-6 (a) A vector ($5.4 \angle 326^\circ$) (b) A vector $5.4 \angle -34^\circ$.

A vector quantity has both magnitude and direction. Figure 12-6a shows a vector with positive angle ($5.4 \angle 326^\circ$), while Figure 12-6b shows a vector ($5.4 \angle -34^\circ$) with negative angle.

In electrical circuits, a sinusoidal voltage may be represented by

	$V = V_{\text{rms}} \angle \theta$	(12.14)
--	------------------------------------	-----------

Where the uppercase V , indicates that the quantity is a phasor, having both magnitude and phase. The magnitude is usually RMS. The phase angle is in degrees. The polarity is very important: + means that the signal leads the reference; while – means that the signal lags the reference.

Example 12-5

Write the phasor form for the following signal and draw the phasor diagram. Use a scale of $1 \text{ cm} = 100 \text{ V}_{\text{rms}}$.

	$v = 300 V_p \sin(377t - 45^\circ)$	
--	-------------------------------------	--

Solution:

$$\begin{aligned}
 V_{\text{rms}} &= \frac{V_p}{\sqrt{2}} \\
 &= \frac{300}{\sqrt{2}} = 212.16 \text{ V}
 \end{aligned}$$

$$V = 212.16 \angle -45^\circ$$

The phasor diagram is shown in Figure 12-7.

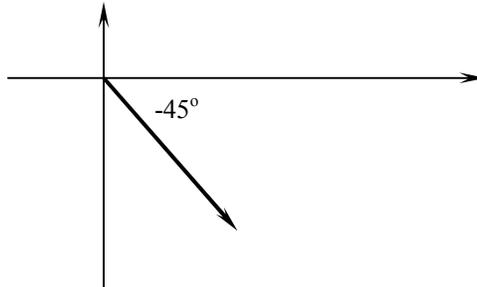

Figure 12-7 Phasor diagram of Example 12-5.

12.3.2 Rectangular Form

The horizontal and vertical components denote a complex number. The angled vector is taken to be the hypotenuse of a right triangle, described by the lengths of the adjacent and opposite sides. These two dimensional figures (horizontal and vertical) are symbolized by two numerical figures. In order to distinguish the horizontal and vertical dimensions from each other, the vertical is prefixed with a lower-case “*i*” (in pure mathematics) or “*j*” (in electronics). Figure 12-8 shows that a point on a complex plane located by a phasor could be described in rectangular form.

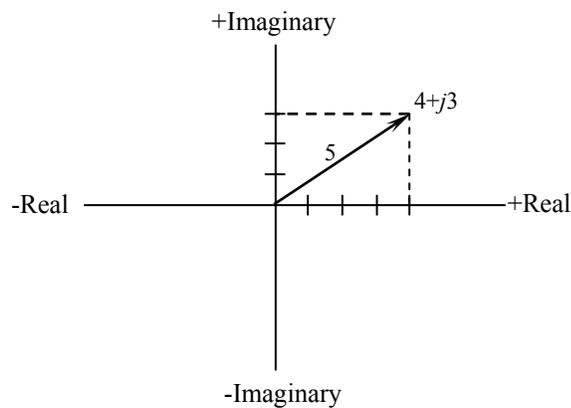

Figure 12-8 A point on the complex plane located by the phasor $4+j3$ expressed in the rectangular form.

Focus on Mathematics

Complex Algebra

A complex number is the sum of a real number and an imaginary number [$A = \text{Real (A)} + j \text{ Imaginary (A)}$]. We know what real numbers are since we use them very often. What are imaginary numbers? The answer to this question is related to another question.

What is the square root of minus one ($\sqrt{-1}$)? The answer is j ! Any number of the form j is called *imaginary number*. Sometimes, the letter i is used to define the imaginary number. Electrical engineers use j because i is used for instantaneous current.

Example 12-6

Express $\sqrt{-16}$ as an imaginary number.

Solution: Write

	$\sqrt{-16} = \sqrt{-1} \times \sqrt{16}$	
--	---	--

Replace $\sqrt{-1}$ with j , then

	$\sqrt{-16} = j4$	
--	-------------------	--

15.3.3 Transforming Forms

Consider the triangle in Figure 12-9. The hypotenuse is labeled as C . The angle is θ . A represents the real value and B represents the imaginary value of the rectangular form.

	$V = C \angle \theta = A + jB$	(12.15)
--	--------------------------------	---------

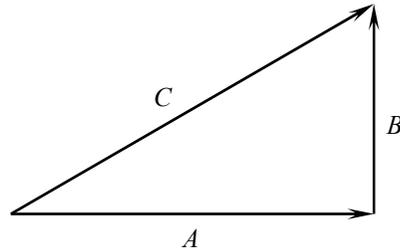

Figure 12-9 Relation between polar and rectangular forms.

To convert from the polar to the rectangular form of a phasor, you must convert $C\angle\theta$ into A and B . From trigonometry, the cosine of an included angle relates the length of the adjacent side and the length of the hypotenuse.

	$\cos \theta = \frac{\text{Adjacent}}{\text{Hypotenuse}} = \frac{A}{C}$ $\sin \theta = \frac{\text{Opposite}}{\text{Hypotenuse}} = \frac{B}{C}$	(12.16)
--	---	---------

To convert from rectangular form to polar form requires a different set of trigonometric relationships.

	$C = \sqrt{A^2 + B^2}$ $\tan \theta = \frac{B}{A}$	(12.17)
--	--	---------

Taking the inverse tangent of each side leaves θ as

	$\theta = \tan^{-1}\left(\frac{B}{A}\right)$	(12.18)
--	--	---------

In general, any load in rectangular form may be converted into polar form as the following

	$Z = R + jX_L$ $Z = \sqrt{R^2 + X_L^2} \angle \tan^{-1}\left(\frac{X_L}{R}\right)$	(12.19)
--	--	---------

Example 12-7

Convert each of the following polar phasors into their rectangular form.

- a) $V = 100 V_{\text{rms}} \angle 60^\circ$, and
 b) $V = 100 V_{\text{rms}} \angle -60^\circ$

Solution:

- a) $V = 50 V_{\text{rms}} + j86.6 V_{\text{rms}}$
 b) $V = 50 V_{\text{rms}} - j86.6 V_{\text{rms}}$

Example 12-8

Convert each of the following polar phasors into their rectangular form.

- a) $V = 2 V_{\text{rms}} \angle 45^\circ$
 b) $V = 240 V_{\text{rms}} \angle -160^\circ$

Solution:

- a) $V = 1.414 V_{\text{rms}} + j1.414 V_{\text{rms}}$
 b) $V = -225.526 V_{\text{rms}} - j82.084 V_{\text{rms}}$

12.3.4 Euler's Identity

Euler's identity forms the basis of phasor notation. It is named after the Swiss Mathematician Leonard Euler. It states, the identity defines the complex exponential $e^{j\theta}$ as a point in the complex plane. It may be represented by real and imaginary components:

	$e^{j\theta} = \cos\theta + j\sin\theta$	(12.20)
--	--	---------

Figure 12-10 shows how the complex exponential may be visualized as a point (or vector, if referenced to the origin) in the complex plane. The magnitude of $e^{j\theta}$ is equal to 1

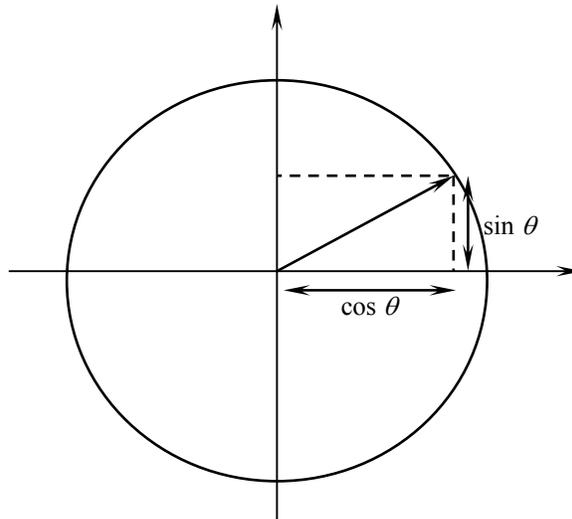

Figure 12-10 Euler's identity.

	$ e^{j\theta} = 1$	(12.21)
--	---------------------	---------

since

	$ \cos \theta + j \sin \theta = \sqrt{\cos^2 \theta + \sin^2 \theta} = 1$	(12.22)
--	--	---------

Remember that writing Euler's identity corresponds to equating the polar form of a complex number to its rectangular form

	$A e^{j\theta} = A \cos \theta + j A \sin \theta = A \angle \theta$	(12.23)
--	---	---------

Simply, Euler's identity is a trigonometric relationship in the complex form. To see how complex numbers are used to represent sinusoidal signals, we may rewrite the expression for a generalized sinusoid using Euler's equation:

	$A \cos (wt + \theta) = \text{Re} (A e^{j (wt + \theta)})$	(12.24)
--	--	---------

Equation (12.24) is simplified as

	$A \cos (wt + \theta) = \text{Re} (A e^{j (wt + \theta)}) = \text{Re} (A e^{j\theta} e^{j wt})$	(12.25)
--	---	---------

Example 12-9

Draw the phasor diagram of the following signal. Use a scale of 1 cm = 100 V_{rms}.

$$V = 300 V_{rms} - j 150 V_{rms}$$

Solution: See Figure 12-11.

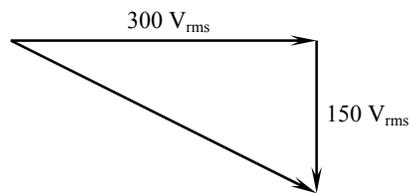

Figure 12-11 Rectangular phasor plot of Example 12-9.

Focus on Mathematics

Adding Phasors

To add phasor quantities, express each in rectangular form and:

1. Add the real parts of the phasors.
2. Add the imaginary parts of the phasors.
3. Form the sum as a phasor written in rectangular form.

Example 12-10

Add $5 + j4$ and $5 + j6$

Solution: Follow steps 1 to 3

	$5 + j4$ $5 + j6$ <hr style="width: 50%; margin: 0 auto;"/> $10 + j10$	
--	--	--

The answer is $10 + j10$

Focus on Mathematics***Subtracting Phasors***

To subtract phasor quantities, express each in rectangular form

1. Change the sign of both the real and the imaginary part of the phasor to be subtracted.
2. Add the phasors following the steps in the previous box.

Example 12-11

Subtract $10 - j4$ from $15 + j8$

Solution: Change the signs of $10 - j4$. Accordingly the answer is

$-(10 - j4) = -10 + j4$, Now add

	$15 + j8$	
	$-10 + j4$	
	$5 + j12$	

The answer is $5 + j12$

Focus on Mathematics***Multiplying Phasors*****Rectangular Form**

To multiply phasor quantities in rectangular form, multiply the numbers as if they were two binomials

1. Distribute the real part of the first complex number over the second complex number.
2. Distribute the imaginary part of the first complex number over the second complex number.
3. Replace j^2 with -1 .
4. Combine like terms.
5. Form the product as a phasor written in rectangular form.

Example 12-12

Multiply $3 + j2$ and $4 - j5$

Solution: Follow steps 1 to 5

Distribute $(3 + j2)$ over $(4 - j5)$. This means

$$(3 + j2)(4 - j5) = 12 - j15 + j8 - j^2 10$$

Replace j^2 with -1 . This yields

$$12 - j15 + j8 + 10$$

Combine like terms to obtain the answer

$$22 - j7$$

Focus on Mathematics***Multiplying Phasors*****Polar Form**

To multiply phasor quantities in polar form

1. Multiply the magnitudes.
2. Add the angles.
3. Form the products as a phasor written in polar form.

Example 12-13

Multiply $4\angle 15^\circ$ and $6\angle 25^\circ$

Solution: Follow steps 1 to 3

Multiply by magnitudes:

$$4 \times 6 = 24$$

Add the angles:

$$15^\circ + 25^\circ = 40^\circ$$

The answer is $24\angle 40^\circ$

Focus on Mathematics

Dividing Phasors

Rectangular Form

To divide phasor quantities in rectangular form

1. Multiply the denominator and the numerator by the complex conjugate of the denominator.
4. Divide the real number and the imaginary number of the numerator by the denominator.
5. Form the quotient as a phasor written in rectangular form.

Example 12-14

Divide $(15 + j10)$ by $(2 + j1)$

Solution: Follow steps 1 to 5

	$\frac{15 + j10}{2 + j1}$	
--	---------------------------	--

Multiply numerator and denominator by $2 - j1$, the complex conjugate of $2 + j1$. This is represented as

	$\frac{(15 + j10)(2 - j1)}{(2 + j1)(2 - j1)}$ $= \frac{30 - j15 + j20 - j^2 10}{4 - j^2 1}$ $= \frac{40 + j5}{5}$	
--	---	--

Divide the real and the imaginary number of the numerator

	$\frac{40}{5} + \frac{j5}{5}$	
--	-------------------------------	--

The answer is $8 + j1$

Focus on Mathematics***Dividing Phasors*****Polar Form**

To divide phasor quantities in polar form

1. Divide the magnitudes.
2. Subtract the angle of the denominator from the angle of the numerator.
3. Form the quotient as a phasor written in polar form.

Example 12-15

Divide $30\angle 40^\circ$ by $6\angle 20^\circ$

Solution: Follow steps 1 to 3

	$\frac{30}{6} = 5$	
--	--------------------	--

Subtract 20° from 40° . That is $40^\circ - 20^\circ = 20^\circ$

The answer is $5\angle 20^\circ$

Focus on Mathematics***Power of a Phasor***

To raise a phasor to a power, express the phasor in polar form, first and then:

1. Raise the magnitude to the specified power.
2. Multiply the angle by the exponent.
3. Form the solution

Example 12-16

Solve $(30\angle 25^\circ)^2$

Solution: Follow steps 1 to 3

Raise 30 to the second power: $30^2 = 900$

Multiply 25° by 2: $25^\circ \times 2 = 50^\circ$

Form the equation to find the answer: $900\angle 50^\circ$.

Example 12-17

Solve $(3 + j4)^2$

Solution: Follow steps 1 to 3

First, express $(3 + j4)$ in polar form:

$$3 + j4 = 5\angle 53.13^\circ$$

Raise 5 to the second power: $5^2 = 25$

Multiply 53.13 by 2: $53.13 \times 2 = 106.26^\circ$

The answer is: $25\angle 106.26^\circ$

12.4 ELECTRICAL SYSTEMS OF PHASORS

Phasors may be added, subtracted, multiplied, and divided. Those operations can be applied to electrical systems. They provide significant meaning to the systems under study. The most insightful phasor operation is addition.

	$V_{\text{total}} = V_1 + V_2$	(12.26)
--	--------------------------------	---------

To add phasors manually, convert the phasors into rectangular form

	$V_1 = A_1 + jB_1$	
	$V_2 = A_2 + jB_2$	

To complete the process, add the real parts together and the imaginary parts together

	$V_{\text{total}} = (A_1 + A_2) + j(B_1 + B_2)$	
--	---	--

12.4.1 Simple Vector Addition

If the current in an AC circuit is described as 50 mA at -60° , it means that the current waveform has amplitude of 50 mA, and it lags 60° behind the reference waveform, usually assumed to be the main source voltage waveform.

Example 12-18

Find the total voltage across the terminals of the circuit shown in Figure 12-12. The circuit contains two sources connected in series: 3 V with 0° and 4 V with 0° .

Solution: Total length = $3 + 4 = 7$ V (angle is 0°)

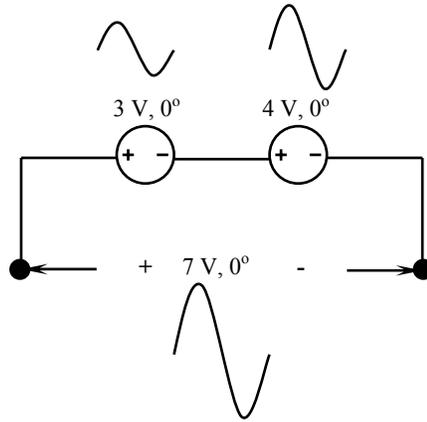

Figure 12-12 Two sources connected in series.

Example 12-19

Find the total voltage across the terminals of the circuit shown in Figure 12-13. The circuit contains two sources connected in series: 3 V with 0° and 4 V with 180° .

Solution:

Total length = $3 - 4 = -1\text{ V}$ (at 0°), or
 Total length = $4 - 3 = 1\text{ V}$ (at 180°)

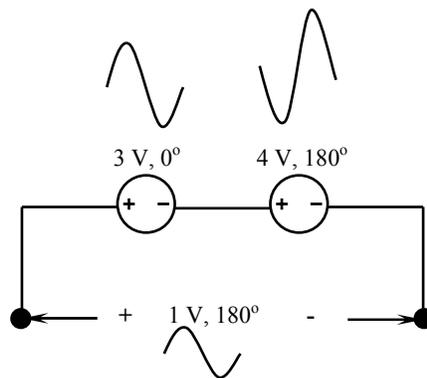

Figure 12-13 Two sources connected in series.

12.4.2 Complex Vector Addition

If vectors with uncommon angles are added, their magnitudes (lengths) add up quite differently than that of scalar magnitudes:

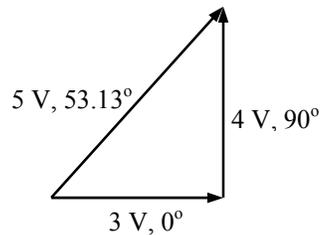

Figure 12-14 Addition of two complex values.

If two AC voltages, 90° out of phase, are added together by being connected in series, their voltage magnitudes do not directly add or subtract as with scalar voltages in DC. Instead, these voltage quantities are complex quantities, and just like the above vectors, which add up in a trigonometric fashion. For example, in Figure 12-14, a 3 V source at 0° added to a 4 V source at 90° results in 5 V at a phase angle of 53.13°.

There is no suitable DC analogy for what we're seeing here with two AC voltages slightly out of phase. DC voltages can only directly aid or directly oppose, with nothing in between. With AC, two voltages can be aiding or opposing one another to any degree between fully-aiding and fully-opposing, inclusive. Without the use of vector (complex number) notation to describe AC quantities, it would be very difficult to perform mathematical calculations for AC circuit analysis.

Example 12-20

Add the following phasors in rectangular form and then express the total in polar.

	$Z_1 = 2 + j3 \Omega$ $Z_2 = 3 - j2 \Omega$	
--	--	--

Solution: $Z_{\text{total}} = 5 + j1 = 5.099 \angle 78.7^\circ$

Example 12-21

Subtract the following phasors and express the result in polar form.

	$(250 \text{ A}_{\text{rms}} \angle -45^\circ) - (100 \text{ A}_{\text{rms}} \angle 75^\circ)$	
--	--	--

Solution:

	$250 \text{ A}_{\text{rms}} \angle -45^\circ = 176.77 \text{ A}_{\text{rms}} - j176.77 \text{ A}_{\text{rms}}$ $100 \text{ A}_{\text{rms}} \angle 75^\circ = 25.88 \text{ A}_{\text{rms}} + j96.60 \text{ A}_{\text{rms}}$ $(176.77 \text{ A}_{\text{rms}} - j176.77 \text{ A}_{\text{rms}}) - (25.88 \text{ A}_{\text{rms}} + j96.60 \text{ A}_{\text{rms}})$ $150.89 \text{ A}_{\text{rms}} - j80.17 \text{ A}_{\text{rms}} = 171 \text{ A}_{\text{rms}} \angle -28^\circ$	
--	--	--

12.3 RESISTIVE LOADS

In a DC circuit, there is one basic type of load, which is resistive. This is not true in AC circuit. AC circuits have three different types of loads: resistive, inductive, and capacitive. Each of these loads produces a different circuit condition. Voltage divided by current in DC circuits is called resistance. However, for AC circuits it is called impedance. The impedance is the opposition an element offers to a sinusoidal current. It is a phasor quantity.

A circuit having pure resistance would have the AC through it and the voltage across it rising and falling together. The current and voltage may not have the same amplitude, but they are in phase. Any time that a circuit contains resistance, heat will be produced.

Voltage and current are in phase with each other in a pure resistive circuit as shown in Figure 12-15 (a). True power can be produced only when both current and voltage are either positive or negative. When like signs are multiplied, the product is positive and when unlike signs are multiplied the product is negative. Since the current and voltage are either positive or negative at the same time, the product, watts, will always be positive.

The impedance in AC circuits is defined through Ohm's law

	$Z = \frac{V}{I}$	(12.26)
--	-------------------	---------

The impedance diagram of a resistor is a phasor whose length is R (along the $+x$ axis) as shown in Figure 12-15 (b).

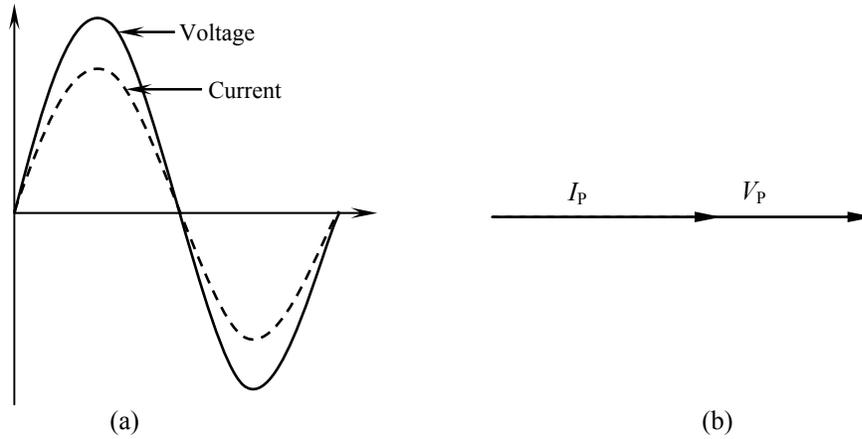

Figure 12-15 (a) Voltage in phase with current. (b) Phase angle between voltage and current is 0° .

When sinusoidal current flows through the impedance, we have

	$v(t) = i(t) \times R$	(12.27)
--	------------------------	-----------

where

	$i(t) = I_p \sin(\omega t)$	
--	-----------------------------	--

then

	$v(t) = RI_p \sin(\omega t)$	
--	------------------------------	--

Now convert the above equation from time domain form into phasors

	$V = R \times (I_{rms} \angle 0^\circ)$	
--	---	--

Substitute into Equation (12.26), we obtain

	$Z = \frac{(R \times I_{rms} \angle 0^\circ)}{(I_{rms} \angle 0^\circ)}$	
--	--	--

To divide phasors, divide the magnitudes and subtract the angles

	$Z = R\angle 0^\circ$	(12.28)
--	-----------------------	---------

The impedance of a resistor has the magnitude of the resistor. Therefore, its units are ohms. The voltage across the resistor is in phase with the current through the resistor since the phase angle is 0° . The 0° phase shift indicates that the voltage across the resistor is in phase with the current through it. The impedance of resistor has no imaginary part.

	$Z_R = R + j0$	
--	----------------	--

Example 12-22

Calculate the phasor current through a $100\text{-}\Omega$ resistor assuming a voltage of $(100\text{ V}_{\text{rms}}\angle 0^\circ)$ applied across it.

Solution: Apply Ohm's law

$$I = \frac{(100\text{ V}_{\text{rms}}\angle 0^\circ)}{(100\Omega\angle 0^\circ)} = 1\text{ A}_{\text{rms}}\angle 0^\circ$$

12.6 INDUCTIVE LOADS

12.6.1 Inductance

The inductance of an inductor (L) is measured in henries (H). It depends upon the physical make up of the coil such as the length (l), cross-sectional area (A), number of turns of wire (N), and the permeability of the material contained in the core (μ). This is expressed mathematically as

	$L = \frac{N^2\mu A}{l}$	(12.29)
--	--------------------------	---------

Inductance is a primary load in AC circuits. Some amount of inductance is present in all AC circuits because of the continually changing magnetic field. Circuits are generally considered to contain inductance when any type of load that contains a coil is used. Loads such as motors, transformers, and chocks all contain coils of wire.

It is known that whenever current flows through a coil, a magnetic field is created around the wire. If the amount of current decreases, the magnetic field will collapse. In the case of a circuit having inductance, the opposing force of the counter EMF would be enough to keep the current from remaining in phase with the applied voltage. In a DC circuit containing pure inductance the current takes time to rise to maximum even though the full-applied voltage is immediately at maximum.

12.6.2 Inductive Reactance

The inductor in Figure 12-16 is connected to an AC voltage source. This causes the magnetic field to continually increase, decrease, and reverse polarity. Since the magnetic field changes magnitude and direction, a voltage is induced in the coil as shown in Figure 12-17. This induced voltage is 180° out of phase with the applied voltage. The induced voltage can limit the flow of current through the circuit in a manner similar to resistance. This current-limiting property of the inductor is called reactance (X). Since this reactance is caused by inductance, it is called inductive reactance (X_L). It is measured in ohms just as the resistance is

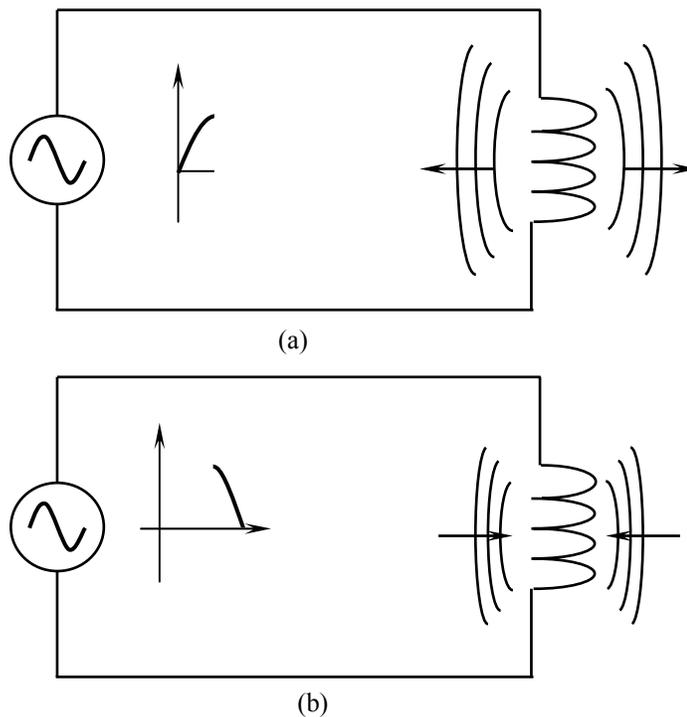

Figure 12-16 (a) Magnetic field increases around the coil as current flows through the coil. (b) Magnetic field decreases as current flow decreases.

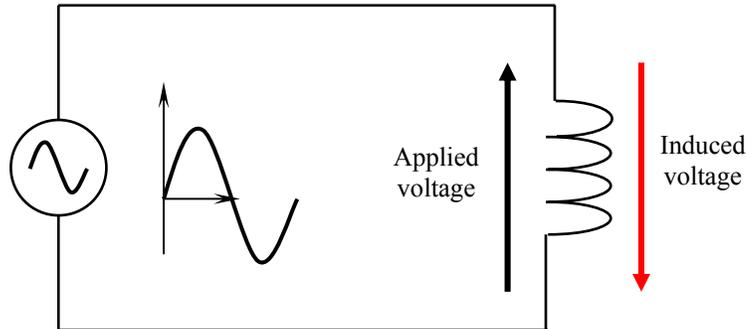

Figure 12-17 Applied voltage and induced voltage across a coil.

	$X_L = \omega L = 2\pi fL$	(12.30)
--	----------------------------	---------

The voltage and current relationship for an inductor involves a derivative. The voltage across the inductor depends on how rapidly the current through it changes

	$v_L = L \frac{di}{dt}$	(12.31)
--	-------------------------	---------

where

	$i = I_p \sin(\omega t) = I_{rms} \angle 0^\circ$	
--	---	--

The derivative of a sinusoidal current is calculated as

	$\frac{di}{dt} = \omega I_p \sin(\omega t + 90^\circ)$	
--	--	--

Substitute this into Equation (12.31)

	$v_L = (\omega L) I_p \sin(\omega t + 90^\circ)$	
--	--	--

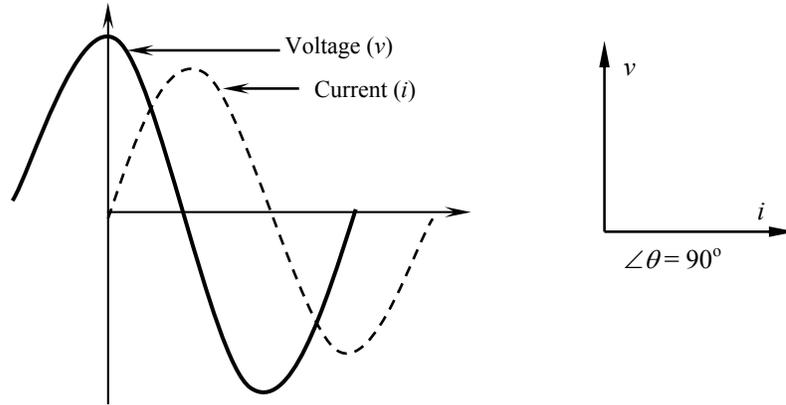

Figure 12-18 (a) Voltage leads the current when AC current passes through an inductor. (b) Phasor diagram shows the lead by 90° .

The above equation shows that there is a phase shift of 90° . Figure 12-18 (a) shows the voltage leading the current when AC current passes through an inductor. The current is at 0° and the voltage drop across the inductor is at $+90^\circ$ (leads) as shown in Figure 12-18 (b). The equation may be expressed as a phasor

	$v_L = (\omega L) \times (I_{rms} \angle 90^\circ)$	
--	---	--

Applying Equation (12.26) to find the impedance

	$Z_L = \frac{(X_L I_{rms} \angle 90^\circ)}{(I_{rms} \angle 0^\circ)}$	
--	--	--

Divide the magnitude and subtract the angle

	$Z_L = (X_L \angle 90^\circ)$	(12.32)
--	-------------------------------	---------

Equation (12.32) indicates that the opposition an inductor presents to a sinusoidal current is proportional to the size of the inductor (L) and the value of the frequency. The voltage is shifted 90° ahead of the current.

In rectangular form, the impedance of the inductor contains a real and imaginary component.

	$Z_L = (0 + j X_L)$	
--	---------------------	--

The impedance diagram of an inductor is shown in Figure 12-19. The length of the phasor X_L lies entirely along the imaginary (+y) axis.

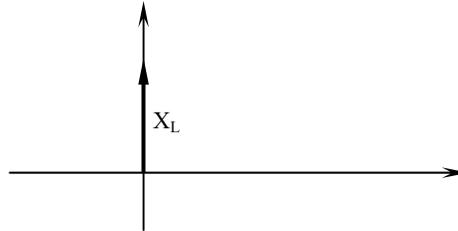

Figure 12-19 Impedance diagram of an inductor.

12.6.3 Power in Inductive Load

In a pure resistive circuit, the true power is equal to the product of the voltage and current. In a pure inductive circuit, however, no true power is produced. In order to produce true power, voltage and current must both be either positive or negative. Since the voltage and current are 90° out of phase with each other in a pure inductive circuit, the current and voltage will be at different polarities 50% of the time and the same polarity 50% of the time.

Example 12-23

The inductor shown in Figure has an inductance of 1 H and is connected to a 120 V 60 Hz line. How much current will flow in this circuit?

Solution:

	$X_L = 2\pi fL$ $X_L = 2 \times 3.1416 \times 60 \times 1$ $X_L = 377 \Omega$	
--	---	--

X_L may be substituted for R in Ohm's law

	$I = \frac{V}{X_L} = \frac{120}{377} = 0.398 \text{ A}$	
--	---	--

15.7 CAPACITIVE LOADS

An inductor opposes a change in current. A capacitor does the opposite. It opposes a change in voltage. Capacitors are used to block DC in electronic circuits. They are formed whenever two conductors run side-by-side.

The current through a capacitance depends on how rapidly the voltage across it changes.

	$i_C = C \frac{dv}{dt}$	(12.33)
--	-------------------------	---------

where

	$v = V_p \sin(\omega t) = V_{rms} \angle 0^\circ$	
--	---	--

Taking the derivative of a sinusoidal voltage

	$\frac{dv}{dt} = \omega V_p \sin(\omega t + 90^\circ)$	
--	--	--

Substitute this into the basic equation for the capacitor

	$i_C = C [\omega V_p \sin(\omega t + 90^\circ)]$	
--	--	--

Rewriting this equation, we get

	$i_C = (\omega C) V_p \sin(\omega t + 90^\circ)$	(12.34)
--	--	---------

Equation (12.34) shows that there is a phase shift of 90° . The voltage is at 0° but the resulting current through the capacitance is at $+90^\circ$ (leads).

The current may be expressed in a phasor form

	$I_C = (\omega C) \times (V_{rms} \angle 90^\circ)$	(12.35)
--	---	---------

The capacitive reactance is defined as

	$X_C = \frac{1}{\omega C}$	(12.36)
--	----------------------------	---------

Equation (12.36) may be rewritten as

	$I_C = \frac{V_{\text{rms}} \angle 90^\circ}{X_C}$	
--	--	--

Using Equation (12.26) to find the impedance, we get

	$Z_C = \frac{V_{\text{rms}} \angle 0^\circ}{\frac{V_{\text{rms}} \angle 90^\circ}{X_C}}$	(12.37)
--	--	---------

Divide the magnitudes and subtract the angles

	$Z_C = X_C \angle -90^\circ$ $= \frac{-j}{\omega C} = \frac{1}{j\omega C}$	(12.38)
--	--	---------

where $\frac{1}{j} = e^{-j\pi/2} = -j$. Therefore, the impedance of a capacitor is a frequency-dependent complex quantity, with the impedance of the capacitor varying as an inverse function of frequency. The capacitor acts as a short circuit at high frequencies, whereas it behaves more as an open circuit at low frequencies. Equation (12.28) indicates that the opposition a capacitor presents to a sinusoidal voltage is inversely proportional to the size of the capacitor (C) and the value of the frequency. The current is shifted 90° ahead of the voltage.

In rectangular form, the impedance of the capacitor contains a real and imaginary component.

	$Z_C = (0 - jX_C)$	(12.39)
--	--------------------	---------

The impedance diagram of a capacitor is shown in Figure 12-20. The length of the phasor X_C lies entirely along the imaginary ($-y$) axis.



Figure 12-20 Impedance diagram of a capacitor.

Example 12-24

Compute the reactance of a $10\ \mu\text{F}$ capacitor at a frequency of (a) 0 Hz, (b) 10 kHz, (c) 1 MHz.

Solution: Use Equation (12.36)

	$X_C = \frac{1}{2\pi fC}$	
--	---------------------------	--

(a) When $f = 0$ Hz

	$X_C = \frac{1}{2\pi(0)(10 \times 10^{-6})} = \infty$	
--	---	--

(b) When $f = 10$ kHz

	$X_C = \frac{1}{2\pi(10 \times 10^3)(10 \times 10^{-6})} = 1.59\ \Omega$	
--	--	--

(c) When $f = 1$ MHz

	$X_C = \frac{1}{2\pi(1.0 \times 10^6)(10 \times 10^{-6})} = 0.016\ \Omega$	
--	--	--

12.8 AC CIRCUIT ANALYSIS

The impedance parameters defined in the previous sections are very useful in solving AC circuit analysis problems, because it makes possible to take advantage of most of the network theorems developed for DC circuits by replacing resistances with complex-valued impedances. Figure 12-21 depicts the impedances of R , L , and C in the complex plane.

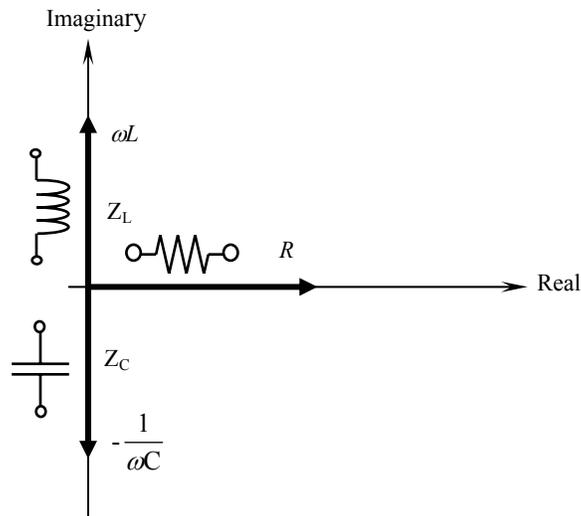

Figure 12-21 Impedances of R , L , and C in the complex plane.

All the rules and laws learned in the study of DC circuits apply to AC circuits including Ohm's law, Kirchhoff's laws, and network analysis methods. The only qualification is that all variables must be expressed in complex form, taking into account phase as well as magnitude, and all voltages and currents must be of the same frequency (in order that their phase relationships remain constant).

It is necessary to emphasize that although the impedance of circuit elements is either purely real (for resistors) or purely imaginary (for inductors and capacitors), the general definition of impedance for an arbitrary circuit should allow for the possibility of having both a real and imaginary part, since practical circuits are made up of more or less complex interconnections of various circuit elements.

Example 12-25

Consider three AC voltage sources in series (Figure 12-22) and use complex numbers to determine additive voltages.

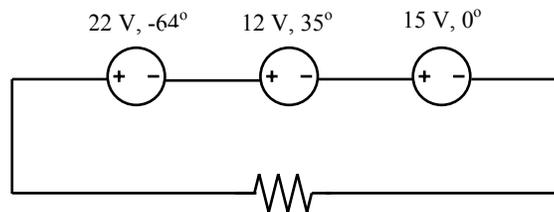

Figure 12-22 Circuit for Example 12-25.

Solution:

	$V_{total} = V_1 + V_2 + V_3$ $V_{total} = 22\angle -64^\circ + 12\angle 35^\circ + 15\angle 0^\circ$	
--	---	--

Graphically, the vectors add up in this manner: The sum of these vectors will be a resultant vector originating at the starting point for the 22 V vector and terminating at the ending point for the 15 V vector. This is shown in Figure 12-23.

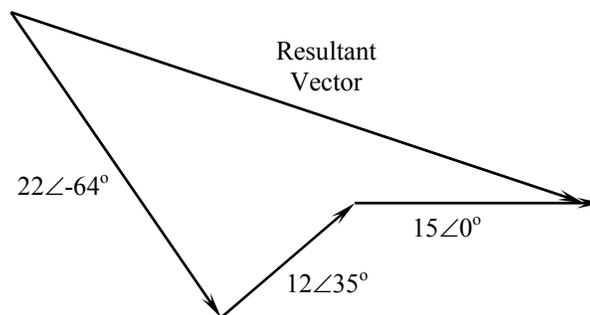

Figure 12-23 Phasor diagram of Example 12-25.

In order to determine what the resultant vector's magnitude and angle are without resorting to graphic images, we can convert each one of these polar-form complex numbers into rectangular form and add. Remember. These figures are

added together because the polarity marks for the three voltage sources are oriented in an additive manner:

	$22\angle -64 = 9.65 - j19.8$ $12\angle 35 = 9.8 + j6.9$ $15\angle 0 = 15 + j0$ $E_{total} = (9.65 - j19.8) + (9.8 + j6.9) + (15 + j0)$ $E_{total} = 34.50 - j12.90V$	
--	---	--

In polar form, this equates to $36.80\text{ V} \angle -20.50^\circ$. What this means in real terms is that the voltage measured across these three voltage sources will be 36.80 V , lagging the 15 volt (0° phase reference) by 20.50° . A voltmeter connected across these points in a real circuit would only indicate the polar magnitude of the voltage (36.80 V), not the angle. An oscilloscope could be used to display two voltage waveforms and thus provide a phase shift measurement, but not a voltmeter. The same principle holds true for AC ammeters: they indicate the polar magnitude of the current, not the phase angle.

This is extremely important in relating calculated figures of voltage and current to real circuits. Although rectangular notation is convenient for addition and subtraction, and was indeed the final step in our sample problem here, it is not very applicable to practical measurements. Rectangular figures must be converted to polar figures (specifically polar magnitude) before they can be related to actual circuit measurements.

Example 12-26

Change the polarity of the three AC voltage sources given in Example 12-25 (Figure 12-24) and use complex numbers to determine additive voltages.

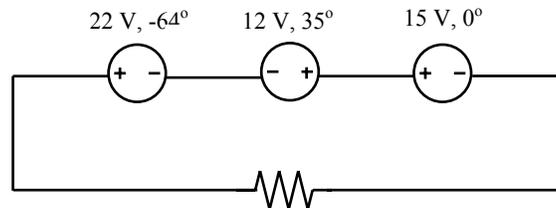

Figure 12-24 Circuit for Example 12-26.

Solution: See Figure 12-25. Note how the 12 V supply's phase angle is still referred to as 35° , even though the leads have been reversed. Remember that the phase angle of any voltage drop is stated in reference to its noted polarity. Even though the angle is still written as 35° , the vector will be drawn 180° opposite of what it was before: The resultant (sum) vector should begin at the upper-left point (origin of the 22 volt vector) and terminate at the right arrow tip of the 15-V vector: The connection reversal on the 12-V supply can be represented in two different ways in polar form: by an addition of 180° to its vector angle (making it $12\text{ V } \angle 215^\circ$), or a reversal of sign on the magnitude (making it $-12\text{ V } \angle 35^\circ$).

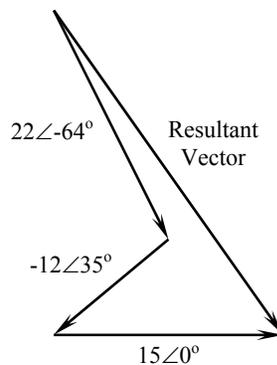

Figure 12-25 Phasor diagram for Example 12-26.

$E_{total} = E1 + E2 + E3$ $E_{total} = (15 + j0) + (-9.82 - j6.9) + (9.65 - j19.80) = 14.81 - j26.65$
--

In polar form, this equates to $30.4964\text{ V } \angle -60.9368^\circ$.

12.9 POWER AND POWER FACTOR

An understanding of load characteristics in electrical power systems involves the concept of power and power factor. The power consumed by a load will be comprised of several individual power components. These components are apparent power, reactive power, and active or real power.

12.9.1 Power Components

The active or real power component of the load is that portion of the load that performs real work. The reactive power component of the load is used to supply

energy that is stored in either a magnetic or electrical field. An example of reactive power being used to supply a magnetic field is the magnetizing current consumed by a transformer or an electric motor. An example of a device that supplies reactive power is the capacitor. Whether or not a load consumes or supplies reactive power is a characteristic of the load itself.

The relationship between these electrical power quantities is best realized by using the power triangle shown in Figure 12-26 (a). In addition Figure 12-26 shows the related impedance triangle.

When an AC power is applied to a reactive load, the voltage is 90° out of phase with the current. When the instantaneous amplitudes of the voltage and current are multiplied, the resultant wave represents the instantaneous power of the reactor. Accordingly, the average power is zero, which means that reactive loads do not dissipate power.

In reference to Figure 12-26 (a), it may be seen that the base of the power triangle represents the real power component, while the vertical component represents the reactive power component. The hypotenuse of the triangle represents the apparent power component, which is calculated as

	$S = \sqrt{P^2 + Q^2}$	(12.40)
--	------------------------	---------

Where:

S = magnitude of power apparent in VA

P = magnitude of real (active) power in W

Q = magnitude of reactive power in VAR

12.9.2 Power Factor

The ratio of real power to apparent power provides us with an important quantity called *power factor*. It is expressed as

	$PF = \frac{P}{S} = \cos(\theta)$	(12.41)
--	-----------------------------------	---------

The ratio of reactive power to apparent power is referred to as the *reactive factor* of the load. It is expressed as

	$RF = \frac{Q}{S} = \sin(\theta)$	(12.42)
--	-----------------------------------	---------

The power factor is a measure of how well the load is converting the total power consumed into real work. A power factor equal to 1.0 indicates that the

load is converting all the power consumed into real work. However, power factor of 0.0 indicates that the load is not producing any real work. In general, the power factor of a load will be between 0.0 and 1.0.

Because only the resistive portion of an AC circuit dissipates power, we are interested in the resistive part of the impedance. The ratio of the circuit resistance to the amplitude of the circuit impedance is called power factor. This is expressed mathematically as

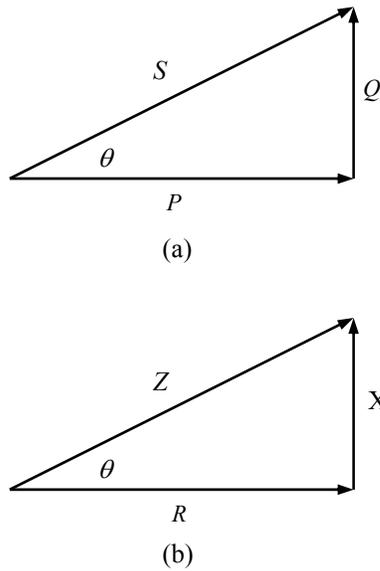

Figure 12-26 (a) Power triangle. (b) Impedance triangle.

	$\text{Power factor} = \frac{R}{ Z }$	(12.43)
--	---------------------------------------	---------

According to Equation (12.28), the impedance of an AC circuit is resistive ($Z = R$). Therefore, the power factor is 1. When the impedance is reactive ($Z = jX$), the power factor is zero. In general, the power factor is related to the phase angle through the impedance diagram (Figure 12-26). This is expressed as

	$\text{Power factor} = \cos(\theta) = R/ Z $	
--	--	--

12.9.3 Leading and Lagging Power Factor

A load in which the current lags the applied voltage is said to have a lagging power factor. However, a load in which the current leads the applied voltage is said to have a leading power factor. The current in an inductive load will lag the

applied voltage by certain angle as shown in Figure 12-27 (a). Therefore, an inductive load will have a lagging power factor. Good examples of inductive loads are transformers, motors, generators, and typical residential loads.

A leading power factor is one in which the current leads the applied voltage by certain angle as shown in Figure 12-27 (b). A power factor correction capacitor is an example for a load having a leading power factor.

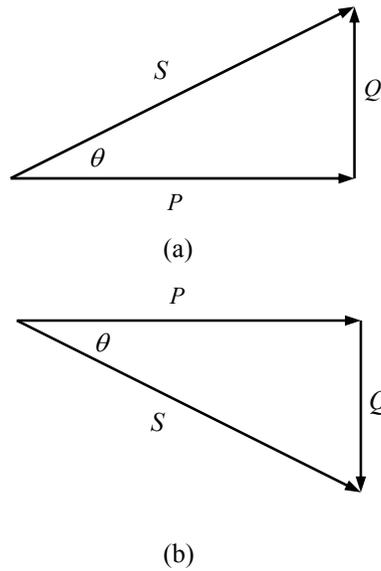

Figure 12-27 (a) Power triangle for lagging power factor. (b) Power triangle for leading power factor.

Example 12-27

Compute the power factor for each of the following cases.

- a) $Z = 100 \angle -30^\circ$
- b) $100 + j50 \Omega$

Solution:

- a) $\theta = -30^\circ$
 $\cos(\theta) = \cos(-30^\circ) = 0.866$
 Power factor is 0.866.

- b) Convert $100 + j50$ to polar form
 $100 + j50 = 111.8 \angle 26.56^\circ$
 $\cos(\theta) = \cos(26.56^\circ) = 0.894$
 Power factor is 0.894.

Example 12-28

A three-phase load consumes 100 kW, and 50 kVAR. Determine the apparent power, reactive factor, and the power factor angle.

Solution: Use Equation (12-40) to find the apparent power

	$S = \sqrt{(100,000)^2 + (50,000)^2} = 111.8 \text{ kVA}$	
--	---	--

Now, use Equation (12-41) to find the power factor

	$\text{PF} = \frac{100,000}{111,803} = 0.8944$	
--	--	--

Use Equation (12-42) to find the reactive power

	$\text{RF} = \frac{50,000}{111,803} = 0.4472$	
--	---	--

12.10 THREE-PHASE AC CIRCUITS

Nearly all-electric power generation and most of power transmission in the world today are in the form of three-phase AC circuits. However, the single-phase supply is the most common supply for domestic premises and other single-occupier premises where the load demand is relatively small. The three-phase system is the usual type of supply for commercial and industrial premises of medium size: schools, hotels, blocks of apartments, hospitals, etc. A three-phase circuit is a combination of three single-phase circuits.

A three-phase power system consists of three-phase generators, transmission lines, and loads. Three-phase systems have two major advantages over single-phase systems: (1) More power is obtained per kilogram of metal from three-phase system, and (2) the power delivered to a three-phase load is constant all the times, instead of pulsing as it does in single-phase system.

12.10.1 Wye-Connected System

A three-phase system consists of three AC sources, with voltages equal in magnitude but differing in phase angle from the others by 120° , and connected at a common point called neutral as shown in Figure 12-28. The current flowing to each load can be found from the following equation

	$I = \frac{V}{Z}$	(12.44)
--	-------------------	---------

Accordingly, the currents flowing in the three phases are

	$I_A = \frac{V \angle 0^\circ}{Z \angle \theta} = I \angle -\theta$ $I_B = \frac{V \angle -120^\circ}{Z \angle \theta} = I \angle -120^\circ - \theta$ $I_C = \frac{V \angle -240^\circ}{Z \angle \theta} = I \angle -240^\circ - \theta$	(12.45)
--	---	---------

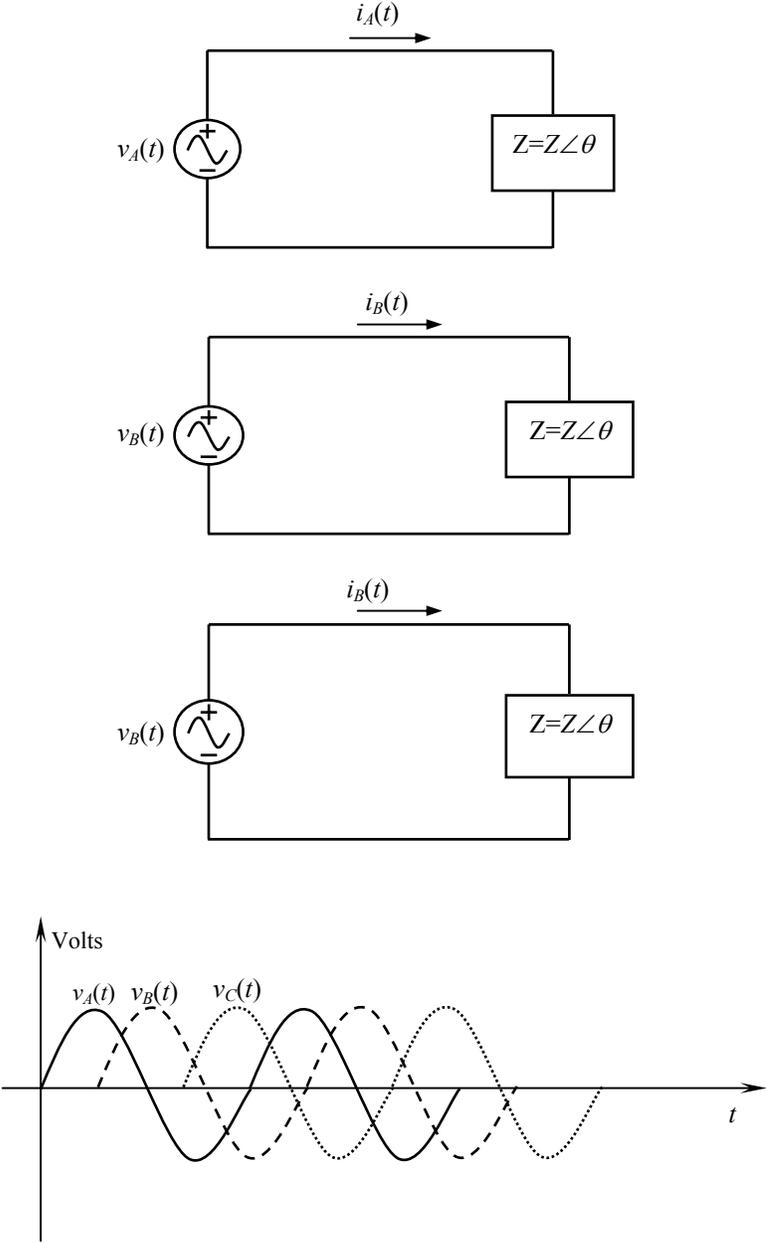

Figure 12-28 (a) Three phases of a generator with their loads. (b) Voltage waveforms of each phase of the generator.

It is possible to connect the negative ends of these three single-phase generators and loads together, so they share a common neutral. This type of connection is called wye or Y. In this case four wires are required to supply power from the three generators to resistive load as shown in Figure 12-29.

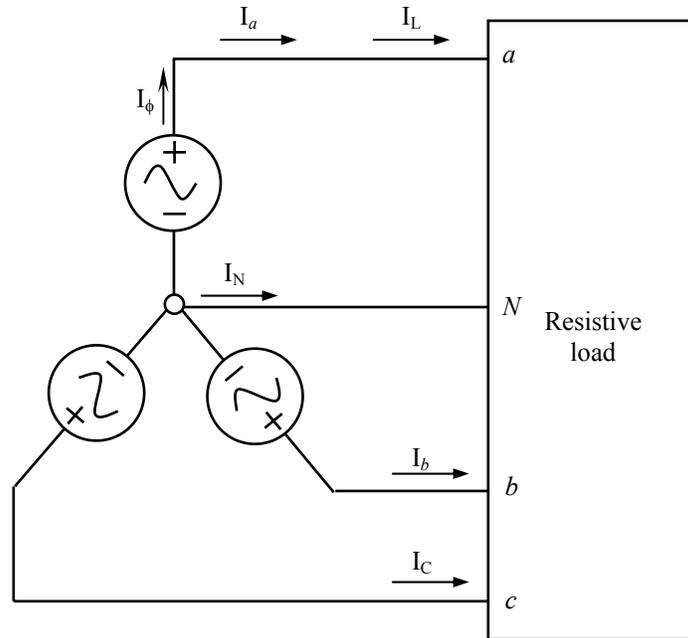

Figure 12-29 Y-connected generator with a resistive load.

The voltages between any two line terminals (a, b, or c) are called *line-to-line voltages*, and the voltages between any line terminal and the neutral terminal are called *phase voltages*.

Since the load connected to this generator is assumed to be resistive, the current in each phase of the generator will be at the same angle as the voltage. Therefore, the current in each phase will be given by

	$I_a = I_\phi \angle 0^\circ$ $I_b = I_\phi \angle -120^\circ$ $I_c = I_\phi \angle -240^\circ$	(12.46)
--	---	---------

It is obvious that the current in any line is the same as the current in the corresponding phase. Therefore, for a Y connection

	$I_L = I_\phi$	(12.47)
--	----------------	-----------

The relationship between line voltage and phase voltage is given by the following equation

	$V_L = \sqrt{3} V_\phi$	(12.48)
--	-------------------------	-----------

12.10.2 Delta (Δ) Connection

Another possible connection is the delta (Δ) connection, in which the three generators are connected head to tail as shown in Figure 12-30. The Δ connection is possible because the sum of the three voltages $V_A + V_B + V_C = 0$.

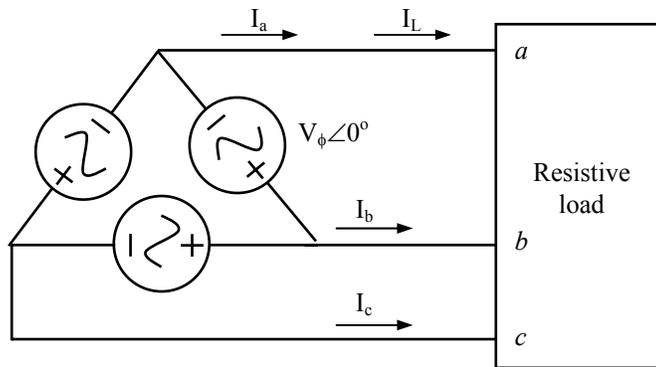

Figure 12-30 Δ -connected generator with a resistive load.

In the case of the Δ connection, it is obvious that the line-to-line voltage between any two lines will be the same as the voltage in the corresponding phase. In a Δ connection

	$V_L = V_\phi$	(12.49)
--	----------------	-----------

The relationship between line current and phase current can be found by applying Kirchhoff's current law at a nodes of the Δ

	$I_L = \sqrt{3} I_\phi$	(12.50)
--	-------------------------	-----------

SUMMARY

1. A sinusoidal signal is mathematically represented in one of two ways: a time-domain forms ($v(t) = A \cos(\omega t + \theta)$) and a frequency-domain (phasor) form ($V(j\omega) = A e^{j\theta} = A \angle \theta$).
2. A phasor is a complex number, expressed in rectangular form and polar form.
3. In rectangular form, the phasor has both real and imaginary parts.
4. In polar form, the phasor consists of a magnitude equal to the peak amplitude of the sinusoidal signal and a phase angle equal to the phase shift of the sinusoidal signal referenced to a cosine signal.
5. The three basic types of AC loads are resistive, inductive, and capacitive.
6. In AC resistive load, the current and voltage are in phase with each other.
7. True power can be produced only during periods of time that both the voltage and current have the same polarity.
8. The impedance of a resistor is simply its resistance.
9. Induced voltage is proportional to the rate of change of current.
10. Induced voltage is always opposite in polarity to the applied voltage.
11. Pure inductive load contains no true power.
12. The impedance of an inductor is $j\omega L \Omega$.
13. The impedance of a capacitor is $1/j\omega C \Omega$.
14. Once a circuit is represented in phasor-impedance form, all analysis techniques practiced in resistive circuits (Chapter 11) apply once all elements are replaced by their frequency-domain equivalents.
15. Phasor analysis can only be performed on single-frequency circuit. Otherwise, principles of superposition must be followed.
16. The power factor is a measure of how well the load is converting the total power consumed into real work.
17. The majority of electricity production is in the form of three-phase power.
18. Three-phase sources or loads can be either Y- or Δ -connected. Both types of sources have three terminals, one for each phase; Y-connected sources have a neutral connection as well.

REVIEW QUESTIONS

1. What is the difference between AC and DC electricity?
2. Find 5 electrical appliances around the house and determine their voltage, current, and power requirements.
3. Identify an AC electrical device in an automobile.
4. How many degrees are the current and voltage out of phase with each other in a pure resistive circuit?
5. How many degrees are the current and voltage out of phase with each other in a pure inductive circuit?
6. To what is inductive reactance proportional?
7. What two factors determine the capacitive reactance of a capacitor?
8. What is power factor and reactive factor?
9. What is meant by a leading and lagging power factor?
10. What types of connections are possible for three-phase generators and loads?

PROBLEMS

12-1 Express each of the following frequencies in Hertz.

- 40 cycles in 5.0 s.
- 120 cycles in 100 ms.
- 1000 revolutions on 0.5 s.
- 500 rotations in 2.0 min.

12-2 Determine the value of the resistive load for a circuit having the phasor diagram shown in Figure 12-31.

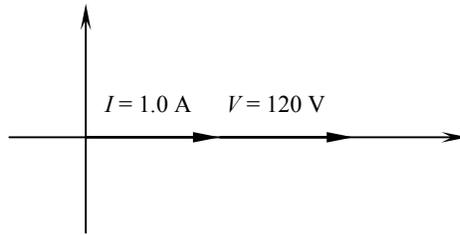

Figure 12-31 Phasor diagram of Problem 12-2.

12-3 Determine the inductance of the inductor in henries whose phasor diagram is given in Figure 12-32. Assume the frequency as 2.4 kHz.

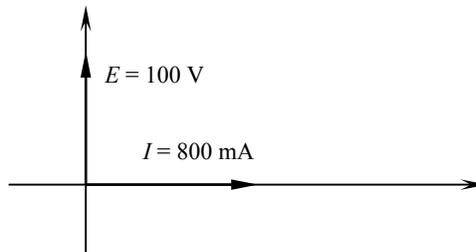

Figure 12-32 Circuit for problem 12-3.

12-4 Determine the capacitance of the capacitor in farads whose phasor diagram is given in Figure 12-33. Assume the frequency as 2 MHz.

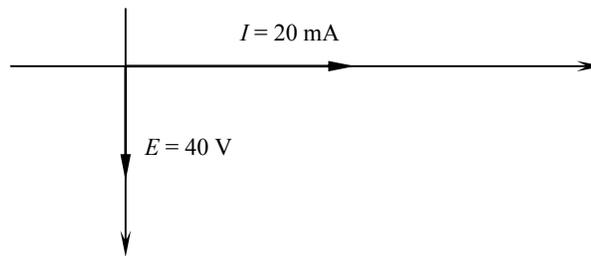

Figure 12-33 Circuit for Problem 16-4.

12-5 Construct the phasor diagram for the circuit shown in Figure 12-34. Find the value of E .

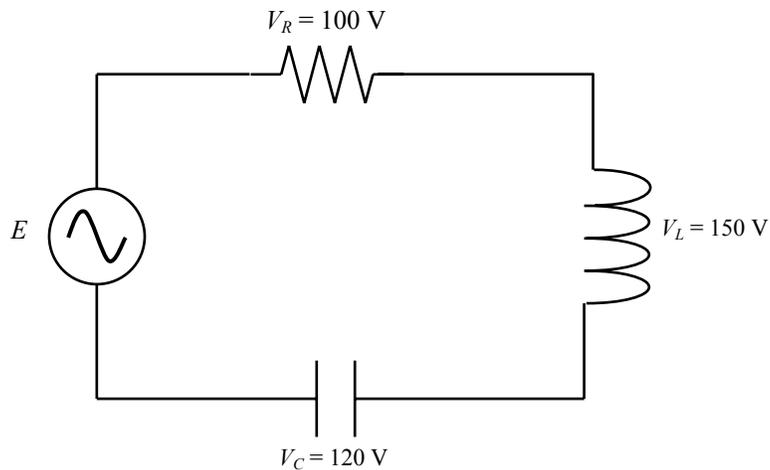

Figure 12-34 Circuit for Problem 16-5.

12-6 Consider a series circuit consisting of a $2.0\text{-}\mu\text{F}$ capacitor and a $500\text{-}\Omega$ resistance. An AC source is powering the circuit with a current of $50\angle 0^\circ$ mA. Draw the circuit and find the source voltage.

12-7 Repeat Problem 16-6. Find the voltage across the capacitor and resistor, then draw the voltage phasor diagram.

12-8 A $100\angle 0^\circ\text{-V}$ (200 kHz) is applied across a parallel circuit consisting of $5.2\text{-k}\Omega$ resistance and a 3.2-H inductor. Find the current through each branch component and find the source current.

12-9 Repeat Problem 12-8. Replace the $5.2\text{-k}\Omega$ resistance with a $3\text{-}\mu\text{F}$ capacitor.

12-10 Determine the circuit components used in each of the four series circuits

- $60 \angle 30^\circ$
- $60 \angle -30^\circ$
- $60 \angle 0^\circ$
- $60 \angle -90^\circ$

12-11 Determine the power dissipated in an AC circuit having a peak source voltage of $E_p = 120\text{ V}$ and an impedance of $Z = 120 \angle 110^\circ$.

12-12 Determine the power factor for each of the following circuit conditions and state if it is leading or lagging

- a. $R = 30\ \Omega$; $|Z| = 90\ \Omega$
- b. $Z = 13 - j6\ \Omega$
- c. $Z = 32 \angle -60^\circ$

12-13 Write the instantaneous equations for voltage and current for the phasor diagram shown in Figure 12-35 at a frequency of 800 Hz .

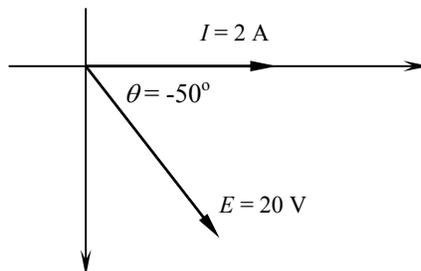

Figure 12-34 Circuit for Problem 12-35.

12-14 Calculate the magnitude of the line current for the following loads:

- a. 10 kVA , unity power factor, 120 V , single-phase system.
- b. 100 kW , 0.9 lagging power factor, $480\text{Y}/260\text{ V}$, three-phase system.

MULTIPLE CHOICE QUESTIONS

- The peak value of a sine wave occurs
 - a. Once each cycle at the positive maximum value.
 - b. Once each cycle at the negative maximum value.
 - c. Twice each cycle at the positive and negative maximum value.
 - d. Twice each cycle at the positive maximum value.

- One of the following is not a right format to express the sinusoid $V \cos \omega t$.
 - a. $V \cos (2\pi ft)$
 - b. $V \cos (2\pi t/T)$
 - c. $V \cos (t - T)$
 - d. $V \sin (2\pi ft - 80^\circ)$

- $\sqrt{-36}$ can be expressed as the following imaginary number
 - a. 6
 - b. $j6$
 - c. -6
 - d. $-j6$

- $-\sqrt{-36}$ can be expressed as the following imaginary number
 - e. 6
 - f. $j6$
 - g. -6
 - h. $-j6$

- Total opposition to current flow in a circuit with resistance and reactance is
 - a. Resistance
 - b. Reactance
 - c. Impedance
 - d. Inductance

- The imaginary part of an impedance is called:
 - a. Resistance
 - b. Reactance
 - c. Admittance
 - d. Conductance

- In a purely inductive circuit
 - a. Current leads voltage by 90° .
 - b. Voltage leads current by 90° .
 - c. Voltage leads current by 180° .
 - d. Current and voltage are in phase.
- In a purely capacitive circuit
 - a. Current leads voltage by 90° .
 - b. Voltage leads current by 90° .
 - c. Voltage leads current by 180° .
 - d. Current and voltage are in phase.
- In the circuit shown in Figure 12-36, what is the voltage across the capacitor?

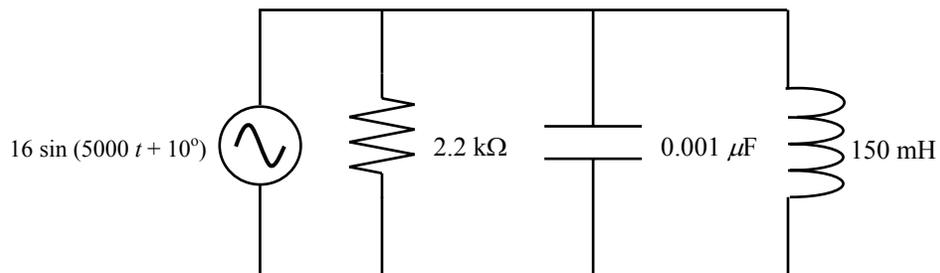

Figure 12-36 Circuit for Problem 1.

- a. $16\angle 10^\circ$
 - b. $12.7\angle 10^\circ$
 - c. $16\angle -80^\circ$
 - d. $12.7\angle 100^\circ$
 - e. None of the above. The answer is
- _____ Is the ratio of true power to apparent power
 - a. Reactive power
 - b. Power ratio
 - c. Power factor
 - d. Phase angle